

DVD STEREO SYSTEM SISTEMA ESTÉREO PARA DISCOS DVD

HT-DV1

OPERATING INSTRUCTIONS MANUAL DE INSTRUCCIONES

Owner's record

For your convenience, record the model number and serial number (you will find them on the bottom of your set) in the space provided below. Please refer to them when you contact your Aiwa dealer in case of difficulty.

Model No.	Serial No. (Lot No.)
HT-DV1	

En (English)

E (Español)

For assistance and information,
call toll free 1-800-BUY-AIWA.
(United States and Puerto Rico)



VIDEO

CLASS-T
DIGITAL AMPLIFIER

8C-AV5-903-01
011217AMK-H9

U

WARNING

TO REDUCE THE RISK OF FIRE OR ELECTRIC SHOCK, DO NOT EXPOSE THIS APPLIANCE TO RAIN OR MOISTURE.



Explanation of Graphical Symbols:

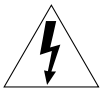

The lightning flash with arrowhead symbol, within an equilateral triangle, is intended to alert the user to the presence of uninsulated "dangerous voltage" within the product's enclosure that may be of sufficient magnitude to constitute a risk of electric shock to persons.



The exclamation point within an equilateral triangle is intended to alert the user to the presence of important operating and maintenance (servicing) instructions in the literature accompanying the appliance.

PRECAUTIONS

Read the Operating Instructions carefully and completely before operating the system. Be sure to keep the Operating Instructions for future reference. All warnings and cautions in the Operating Instructions and on the system should be strictly followed, as well as the safety suggestions below.

Important

This system is designed for the NTSC color systems only.

Installation

- 1 Water and moisture** — Do not use this system near water, such as near a bathtub, sink, swimming pool, or the like.
- 2 Heat** — Do not use this system near sources of heat, including heating vents, stoves, or other appliances that generate heat. This system should not be placed in temperatures less than 5°C (41°F) or greater than 35°C (95°F).
- 3 Mounting place** — Place the system:
 - on a flat, even surface
 - away from strong magnetic fields
 - at least one meter away from any radios or receivers
 Do not place heavy objects on the system.
- 4 Ventilation** — The system should be situated with adequate space around it so that proper heat ventilation is assured. Allow a clearance of 10 cm (4 in.) from the rear and the top of the system, and 5 cm (2 in.) from each side.

- Do not place the system on a bed, rug, or similar surface that may block the ventilation openings.
- Do not install the system in a bookcase, cabinet, or airtight rack where ventilation may be impeded.
- To avoid internal heat build-up, do not cover the ventilation openings on the rear panel.

5 Foreign objects and liquid — Be careful that foreign objects or liquid do not enter the system through the ventilation openings.

6 Carts and stands — The system should be moved with care when placed or mounted on a stand or cart. Sudden stops, excessive force, or an uneven surface may cause the system or cart to fall over.



7 Condensation — Moisture may form on the pickup lens when:

- This system is moved from a cold spot to a warm spot
 - A heating system has just been turned on
 - The system is used in a very humid room
 - The system is cooled by an air conditioner
- When this system has condensation inside, it may not function normally. Should this occur, leave the system for a few hours, then try to operate again.

Electric power

1 Power sources — Connect this system only to power sources specified in the Operating Instructions, and as marked on the system.

2 AC power cord

- When disconnecting the AC power cord, pull it out by the AC power plug. Do not pull the cord itself.
- Never handle the AC power plug with wet hands, as this could result in fire or electrical shock.
- Power cords should be firmly secured to avoid being severely bent, pinched, or walked upon. Pay particular attention to the cord from the system to the power socket.
- Avoid overloading AC power plugs and extension cords beyond their capacity, as this could result in fire or electrical shock.

3 When not in use — Unplug the AC power cord from the AC outlet if the system will not be used for several months or more. When the cord is plugged in, a small electrical current continues to flow into the system, even if the power is turned off.

4 In case of lightning — Immediately disconnect the AC power cord from the AC outlet.

Maintenance

Clean the system only as recommended in the Operating Instructions.

Damage requiring service

Have this system serviced by a qualified service technician if:

- The AC power cord or plug has been damaged
- A foreign object or liquid has entered the system
- The system has been exposed to rain or water
- The system does not seem to operate normally
- The system exhibits a marked change in performance
- The system has been dropped, or the cabinet has been damaged

DO NOT OPEN THE CABINET AND ATTEMPT TO SERVICE THE SYSTEM YOURSELF.

TABLE OF CONTENTS

Introduction

Precautions	2
Before use	4
About symbols	4
Supported disc formats	4
Disc-related terms	5
Types of video CDs	5
Notes on copyright	5
Handling discs	6
Cleaning discs	6
Storing discs	6
Handling the system	6
Cleaning the system	6
Remote control	7
Parts and controls	8
Front panel	8
Remote control	9
Display window	10

Preparations

Connections	11
Connection diagram	11
1 Connecting the DVD player and the amplifier	12
2 Connecting to a TV	12
3 Connecting the speakers	14
4 Connecting the AC power cord	15

Basic Operations

Playback	16
Adjusting the volume	17
Resuming playback	18
Still (pause)	18
Frame advance	18
Slow playback	19
Fast forward/fast reverse	19
Skipping	20
Checking the play time during playback	20
Playing a video CD without using Playback Control (PBC)	20
Sound adjustment	21
Creating a simulated audio surround effect	22
Basic operation of the On-Screen Display (OSD) menu	23
Description of each OSD menu item	24

More Features

Search	26
Title search/track search	26
Chapter search	27
Time search	27
Mark search	28
Random playback	29
Programmed playback	30
Programming tracks	30
Modifying the program	31
Clearing the entire program	31
Repeat playback	32
Repeat playback	32
Repeating a section between two specified points (A-B repeat)	33
Zooming and changing the angle	34
Zooming the picture	34
Changing the angle	34
Changing the audio track	35
Displaying and changing subtitles	36
Playing an MP3 disc	37
Notes on MP3 discs	37
Glossary	37
Playing an MP3 disc	38
On-Screen Display (OSD) menu for the MP3 disc	39
Various MP3 disc operations	39
Connecting external audio equipment	40
Connecting audio equipment with an optical digital input jack	40
Connecting audio equipment with analog input jacks	40

As Necessary

Changing setup values	41
Basic operations in the setup menu	41
On-Screen Menu	42
Disc Languages	43
TV Aspect	45
Ratings	46
Audio Output Setting	47
Language codes	50
Troubleshooting	51
Specifications	52

BEFORE USE

Please read the following before operating the system.

About symbols

Although this system can play DVDs, video CDs, audio CDs and MP3 discs, some of the functions are restricted depending on the type of disc.

The following symbols are used to make distinctions.

No symbols: The function works for DVDs, video CDs and audio CDs.

DVD : Indicates a function or display for DVDs only.

VCD2.0 : Indicates a function or display only for video CDs version 2.0 equipped with PBC (Playback Control).

VCD1.1 : Indicates a function or display only for video CDs version 1.1 not equipped with PBC (Playback Control).



CD : Indicates a function or display for audio CDs only.

MP3 : Indicates a function or display for MP3 discs only.

Playback of MP3 discs is different from that of other kinds of discs. For information about playing MP3 discs, see "PLAYING AN MP3 DISC" on page 37.

Supported disc formats

This system can play discs with the following marks.

	DVD (8 cm disc/12 cm disc)
	Video CD (8 cm disc/12 cm disc)
	Audio CD (8 cm disc/12 cm disc)

In addition, this system can play CD-R or CD-RW discs that contain audio titles or MP3 files.

NOTES

- Depending on the condition of the recording equipment or the CD-R/RW disc itself, some CD-R/RW discs cannot be played on the system.
- The system cannot play CD-R/RW discs that contain no data, or contain kinds of formatted data other than MP3. For more information about MP3, see page 37.
- Do not attach any seal or label to either side (the labeled side or the recorded side) of a disc.
- Do not use irregularly shaped CDs (e.g. heart-shaped or octagonal). It may result in malfunctions.

Note on color system

This system is designed for the NTSC color system only.

DVDs and video CDs are recorded in the PAL and NTSC color systems.

Select DVDs and video CDs recorded in the NTSC color system.

Notes on DVDs and video CDs

Some playback operations of DVDs and video CDs may be intentionally fixed by software manufacturers. As this system plays DVDs and video CDs according to disc content designed by the software manufacturer, some playback features of the system may not be available, or other functions may be added.

Refer also to the instructions supplied with the DVDs and video CDs.

Some DVDs made for business purposes may not be playable on the system.

Region code of the DVD player and DVDs



This system is designed and manufactured for playback of region "1" encoded DVD software. The region code on the labels of some DVDs indicates which type of player can play those discs. This system can play only DVDs labeled "1" or "ALL". If you try to play any other discs, the message "REGIONAL CODE VIOLATION" will appear on the TV screen. Some DVDs may not have a region code label even though their playback is prohibited by area limits.

Note on DVDs recorded with a sampling frequency of 96 kHz

When playing DVDs recorded with a sampling frequency of 96 kHz, the system outputs signals converted to 48 kHz. Note, however, that the system does not play dts audio tracks recorded with a sampling frequency of 96 kHz.

Disc-related terms

Title **DVD**

The longest section of a picture or a musical piece on a DVD, a movie for a picture piece on video software, or an album for a musical piece on audio software. Each title is assigned a title number enabling you to locate the title you want.

Chapter **DVD**

Sections of a picture or a musical piece that are smaller than titles.

A title is composed of several chapters. Each chapter is assigned a chapter number, enabling you to locate the chapter you want. Depending on the disc, no chapters may be recorded.

Track **VCD2.0** **VCD1.1** **CD**

Sections of a picture or a musical piece on a video CD or an audio CD. Each track is assigned a track number, enabling you to locate the track you want.

Scene **DVD** **VCD2.0** **VCD1.1**

Moving pictures and still pictures are divided into sections called "scenes". Each scene is displayed in the menu screen and assigned a scene number, enabling you to locate the scene you want.

A scene is composed of one or more tracks.

Types of video CDs

There are two types of video CDs:

Video CDs equipped with PBC (version 2.0)

VCD2.0

The PBC (Playback Control) function allows you to interact with the system via menus, search functions, or other typical computer-like operations. Moreover, still pictures of high resolution can be played if they are included in the disc.

Video CDs not equipped with PBC (version 1.1)

VCD1.1

Operated in the same way as audio CDs, these discs allow playback of video pictures as well as sound, but they are not equipped with PBC.

Notes on copyright

It is forbidden by law to copy, broadcast, show, broadcast via cable, play in public, or rent copyrighted material without permission.

This product features the copy protection function developed by Macrovision. Copy protection signals are recorded on some discs. When recording and playing the pictures of these discs on a VCR, picture noise will appear. This product incorporates copyright protection technology that is protected by method claims of certain U.S. patents and other intellectual property rights owned by Macrovision Corporation and other rights owners. Use of this copyright protection technology must be authorized by Macrovision Corporation, and is intended for home and other limited viewing uses only unless otherwise authorized by Macrovision Corporation. Reverse engineering or disassembly is prohibited.

BEFORE USE (CONTINUED)

Handling discs

Do not touch the playback side of the disc.
Hold the disc by the edges so that fingerprints will not get on the surface.
Do not stick paper or tape on the disc.

Cleaning discs

Fingerprints and dust on the disc can cause poor picture quality and sound distortion. Before playing, clean the disc with a clean cloth. Wipe the disc from the center out.

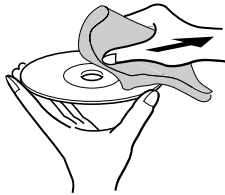

Do not use strong solvents such as alcohol, benzene, thinner, commercially available cleaners, or anti-static spray intended for analog records.

Storing discs

After playing, store the disc in its case.
Do not expose the disc to direct sunlight or sources of heat, or leave it in a parked car exposed to direct sunlight, as there may be a considerable temperature increase inside the car.

Handling the system

When shipping the system

The original shipping carton and packing materials come in handy. For maximum protection, repack the system as it was originally packed at the factory.

When installing the system

The picture and sound of a nearby TV, VCR, or radio may be distorted during playback. In this case, position the system away from the TV, VCR, or radio, or turn off the system after removing the disc.

To keep the surface clean

Do not use volatile liquids, such as insecticide spray, near the system. Do not leave rubber or plastic products in contact with the system for a long period of time. They will leave marks on the surface.

Cleaning the system

To clean the cabinet

Use a soft, dry cloth. If the surfaces are extremely dirty, use a soft cloth lightly moistened with a mild detergent solution. Do not use strong solvents, such as alcohol, benzene, or thinner, as these might damage the surface of the system.

To clean the pickup lens

Use a cotton swab slightly moistened with cleaning fluid. Wipe gently from the center to the edge.

Remote control

Before using the remote control

A battery (CR2025) is already installed in the remote control when shipped from the factory.

Remove the insulating tape from the battery holder by pulling its end as shown below.



PARTS AND CONTROLS

The instructions in this manual refer mainly to the buttons on the remote control. The buttons on the DVD player and amplifier that have the same names as those on the remote control can be used in the same way.

Front panel

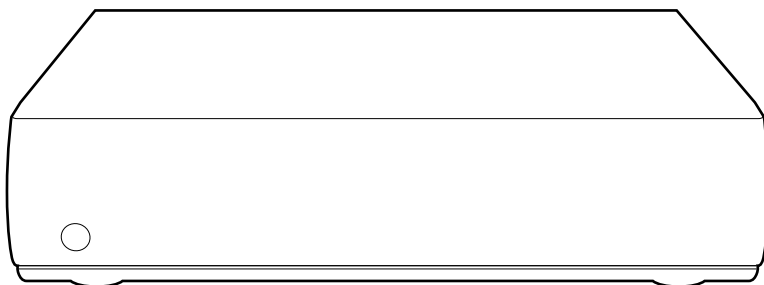

Remote control

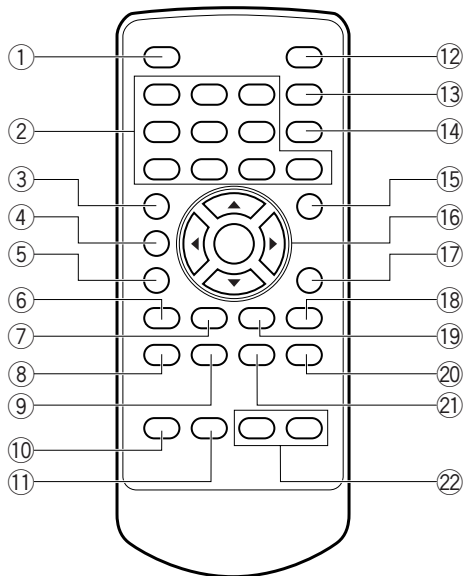

- ① **POWER** button
Press to turn the system on and off.
- ② Number buttons
- ③ **TOP MENU/PBC** button
DVD
• Press to display the title menu of a DVD.
VCD2.0
• Press to turn on or off the PBC (Playback Control) function.
- ④ **MENU** button
DVD
• Press to display menu programs.
VCD2.0
• Press to return to the disc menu when PBC (Playback Control) is on.
- ⑤ **SETUP** button
Press to display the setup menu on the TV screen.
- ⑥ **PLAY MODE** button
Press to enter title/chapter/track/time search, programmed play, random play or repeat play mode.
- ⑦ **◀◀** button
• Press to fast reverse a disc.
• Press to lower the speed of slow playback.
- ⑧ **◀◀◀** button
Press to return to the beginning of the current or previous chapter/track.

- ⑨ **▶▶** button
Press to skip to the next chapter/track.
- ⑩ **SOUND** button
Press to emphasize bass (low frequency) or treble (high frequency) sound or cancel the emphasis on both bass and treble.
- ⑪ **MUTE** button
Press to turn off the audio temporarily. Press again to restore the audio to the previous volume level.
- ⑫ **SURROUND** button
Press to select the audio surround mode.
- ⑬ **TIME** button
Press to display the elapsed time or remaining time of the title/chapter/disc/track currently being played.
- ⑭ **C (Clear)** button
• Press to clear a marked point.
• Press to clear a track when programming tracks.
• Press to cancel an input number in the On-Screen Display (OSD) menu.
• Press to center the zoom area.
- ⑮ **DISPLAY** button
Press to display the On-Screen Display (OSD) menu.
- ⑯ **▲, ▼, ◀, ▶** and **ENTER** buttons
• Press **▲/▼/◀/▶** to select an item or move the zoom area.
• Press **ENTER** to execute or confirm the selected item in a menu.
- ⑰ **↶ RETURN** button
• Press to return to the previous menu.
VCD2.0
• Press to return to the disc menu when PBC (Playback Control) is on.
- ⑱ **||** button
• Press to pause playback.
• Press to advance the picture by one frame.
- ⑲ **▶▶** button
• Press to fast forward a disc.
• Press to start slow playback during pause (still) and raise the speed of slow playback.
- ⑳ **▶** button
Press to start playing a disc.
- ㉑ **■** button
Press to stop playing a disc.
- ㉒ **VOLUME -/+** button
Press to adjust the volume.

CONTINUE

PARTS AND CONTROLS (CONTINUED)

Display window

The system shows on-screen display messages on the screen of the connected TV, as well as LCD indications on the display window of the DVD player. They make operations simple and easy, especially when playing DVDs and video CDs. The instructions in this manual refer mainly to the on-screen display messages on the TV screen.

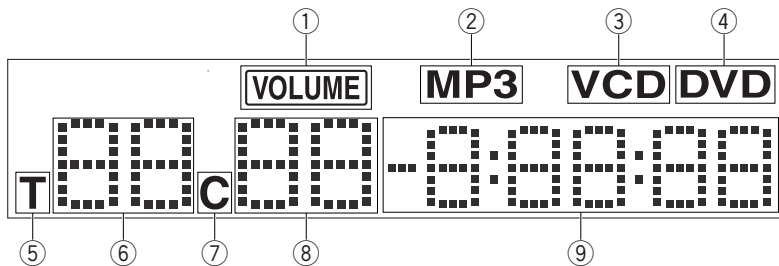

- ① **VOLUME** indicator
Lights up while the volume is adjusted.
- ② **MP3** indicator **MP3**
Lights up when an MP3 disc is loaded.
- ③ Disc indicator
VCD2.0 **VCD1.1**
• "VCD" lights up when a video CD is loaded.
CD
• "CD" lights up when an audio CD is loaded.
- ④ **DVD** indicator **DVD**
Lights up when a DVD is loaded.
- ⑤ **T** (title/track) indicator
Lights up while the total number of titles/tracks or the current title/track number is displayed.
- ⑥ Title/track indication
 - The current title/track number is displayed during playback.
 - In stop mode
 - The current title/track number is displayed when the resume function is on.
 - The total number of titles/tracks is displayed when the resume function is off.
- VCD2.0**
• "PbC" is displayed instead of the track number when PBC (Playback Control) is on.
- ⑦ **C** (chapter) indicator **DVD**
Lights up while the current chapter number is displayed.
- ⑧ Volume/chapter number indication
 - The volume level is displayed during volume adjustment.
- DVD**
 - The current chapter number is displayed during playback.
 - In stop mode
 - The current chapter number is displayed when the resume function is on.
 - No indication when the resume function is off.
- ⑨ Time counter
DVD
 - The elapsed time or remaining time of the current title/chapter is displayed during playback.
 - In stop mode
 - The elapsed time or remaining time of the current title/chapter is displayed when the resume function is on.
 - No indication when the resume function is off.
- VCD1.1**
 - The elapsed time or remaining time of the current track is displayed during playback.
 - In stop mode
 - The elapsed time or remaining time of the current track is displayed when the resume function is on.
 - No indication when the resume function is off.
- VCD2.0**
 - No indication when PBC (Playback Control) is on.
- CD**
 - The elapsed time or remaining time of the current track/disc is displayed during playback.
 - The total play time of the disc is displayed in stop mode.
- MP3**
 - The elapsed time or remaining time of the current track is displayed during playback.
 - No indication in stop mode.

CONNECTIONS

Before making connections

- Connect the AC cords of the system, TV and any external equipment last, after all other connections are finished.
- The picture may be distorted when the subwoofer is placed near the TV set. In this case, place the subwoofer apart from the TV set.

Insert the speaker cords firmly into the speaker terminals.

Loose connection may cause the system's safety device to be activated so that the power is turned off automatically to prevent short circuit. If the power is turned off by activation of the safety device, unplug the AC power cord and reinsert the speaker cords firmly. Then, plug the AC power cord again.

Connection diagram

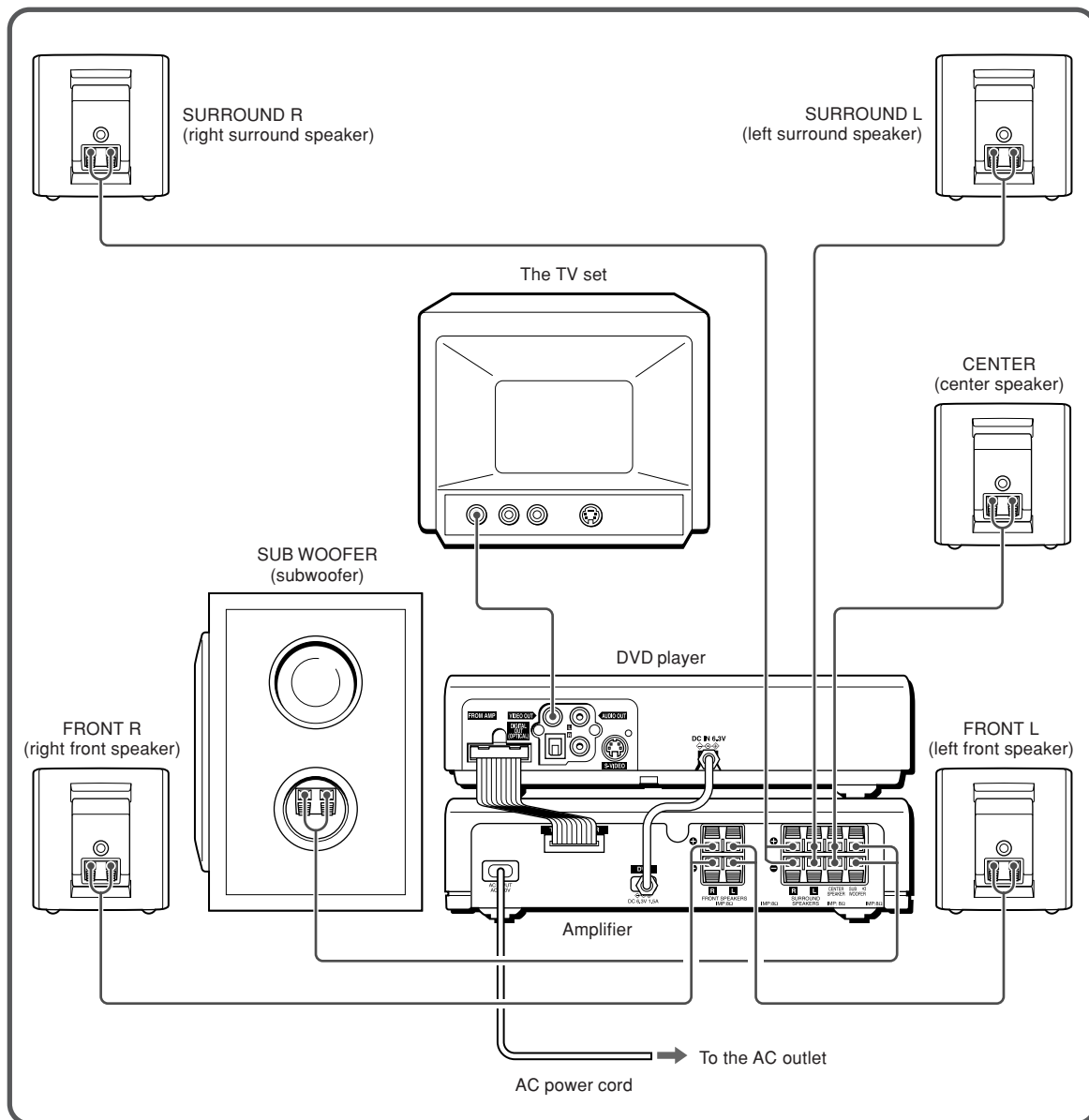

CONNECTIONS (CONTINUED)

1 Connecting the DVD player and the amplifier

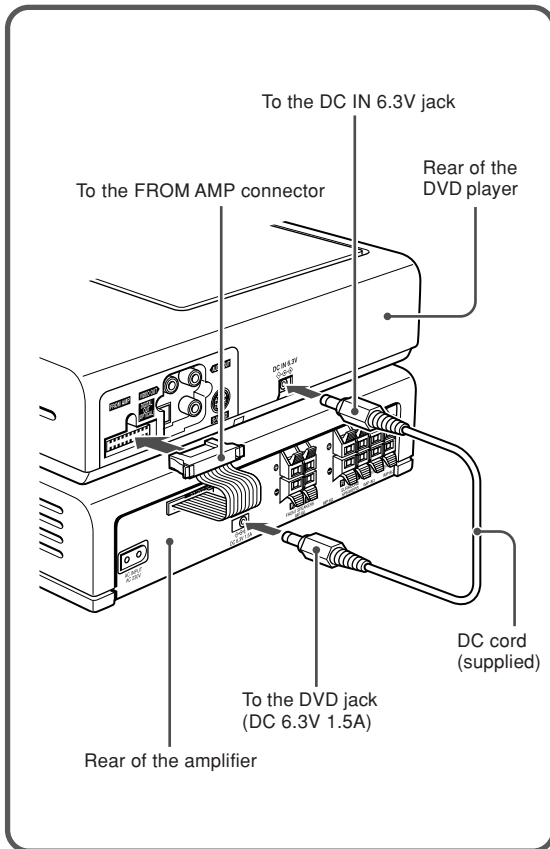

- 1 Place the DVD player on the top of the amplifier. Alternatively, place the DVD player and the amplifier side by side.
- 2 Connect the flat cable of the amplifier to the FROM AMP connector on the DVD player holding the plug with the cable side facing down. The plug clicks into position.
- 3 Connect the DC cord to the DC IN 6.3V jack on the DVD player and to the DVD jack on the amplifier.

2 Connecting to a TV

Connecting to a TV using the supplied video cord

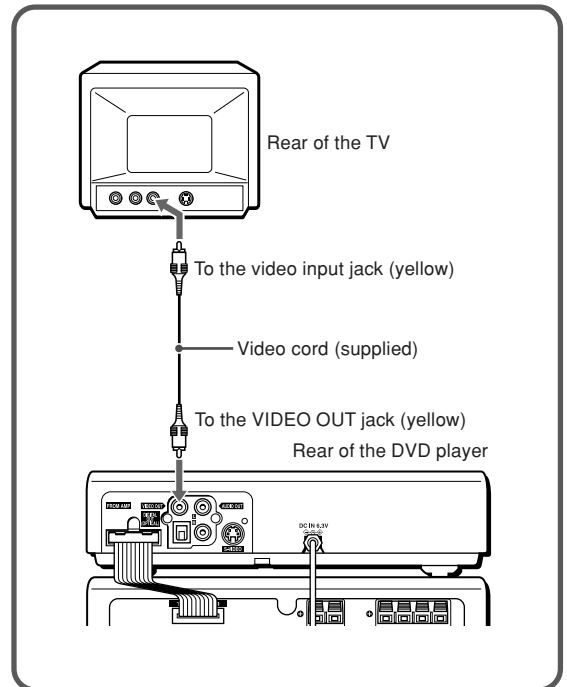

Connecting to a TV with an S-video input connector

For the best possible picture clarity, it is recommended that an S (separate) video cord (not supplied) be used when connecting the DVD player to a TV equipped with an S-video input connector.

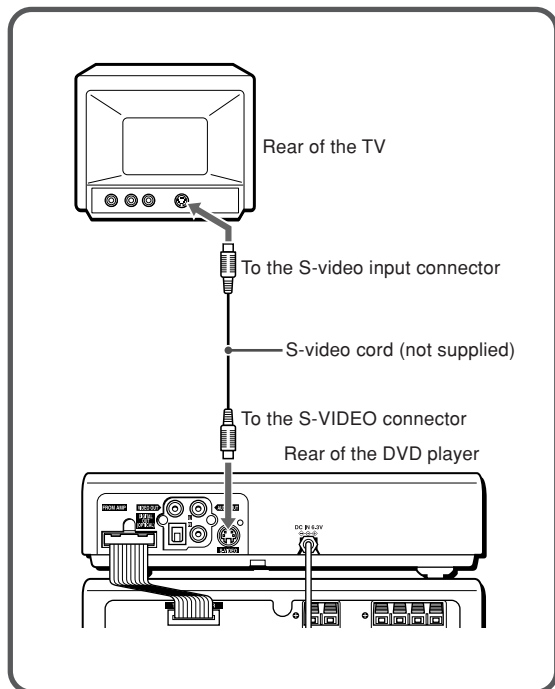

Set the setup menu correctly after connecting a TV

Set the "TV Aspect" of the setup menu according to the TV connected to the system as follows (see "CHANGING SETUP VALUES" on page 41 for details):

TV Aspect:

When the TV has a conventional 4:3 aspect ratio screen:
4:3 LETTER BOX or 4:3 PAN & SCAN

When the TV has a wide screen:
16:9 WIDE

NOTE

If picture noise appears while copy-protected DVDs are played, connect the system directly to a TV. Do not connect through a VCR, TV/VCR or AV selector.

CONNECTIONS (CONTINUED)

3 Connecting the speakers

Speaker arrangement

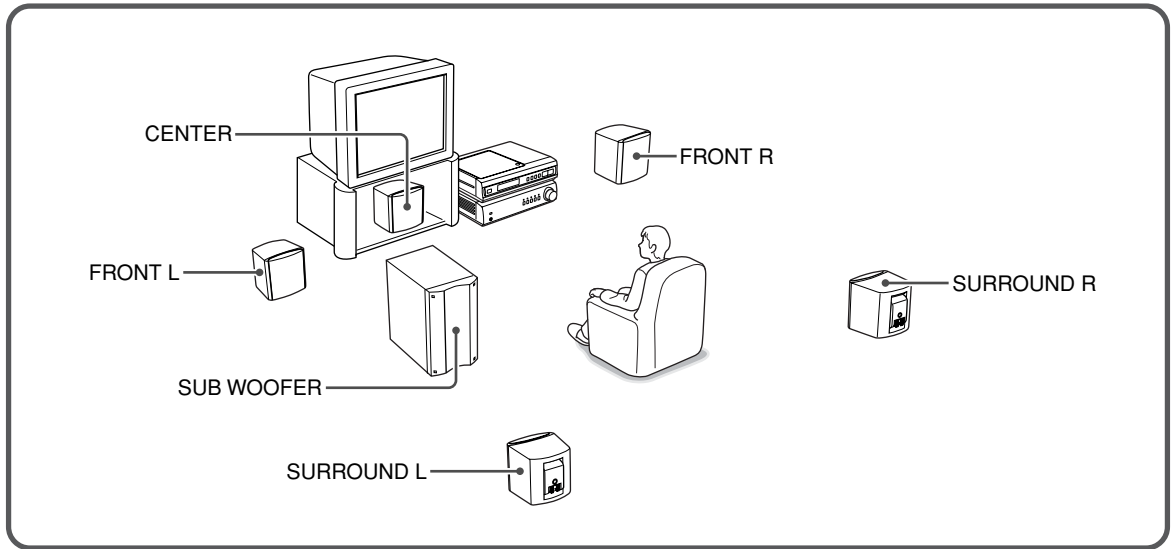

About speaker labels

The five speakers except the subwoofer have the same appearance. You can identify each speaker by the colored label on the rear panel.

Rear of the speaker

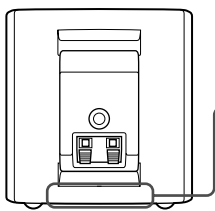

FRONT R: right front speaker, red label
FRONT L: left front speaker, white label
CENTER: center speaker, green label
SURROUND R: right surround speaker, grey label
SURROUND L: left surround speaker, blue label

About speaker cords

The speaker cords can be distinguished from each other by the color of the tapes at their ends. Use the correct speaker cord with the tape color matching each speaker.

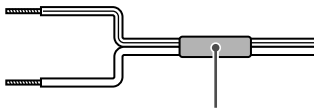

Red: FRONT R (4 m)
White: FRONT L (4 m)
Grey: SURROUND R (10 m)
Blue: SURROUND L (10 m)
Green: CENTER (3 m)
Purple: SUB WOOFER (5 m)

Connecting the FRONT R speaker

Connect the right front speaker to the FRONT SPEAKERS R terminals on the amplifier using the speaker cord with red tapes. The speaker cords with white stripes go to the \oplus terminals.

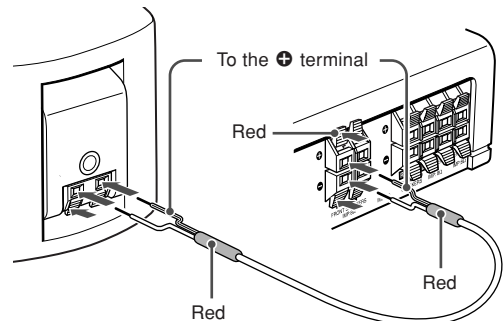

Connecting the other speakers

Connect the other speakers in the same way with the right front speaker.

Use the correct speaker cord with the tape color matching each speaker.

Make sure that the speaker cords with white stripes go to the \oplus terminals.

NOTES

- Use the supplied speakers only.
- As far as possible, install the speakers at the same distance from the listening position.
- Install the center speaker as close as possible to midway between the left and right front speakers.
- Install the left and right surround speakers no farther than the left and right front speakers from the listening position.

4 Connecting the AC power cord

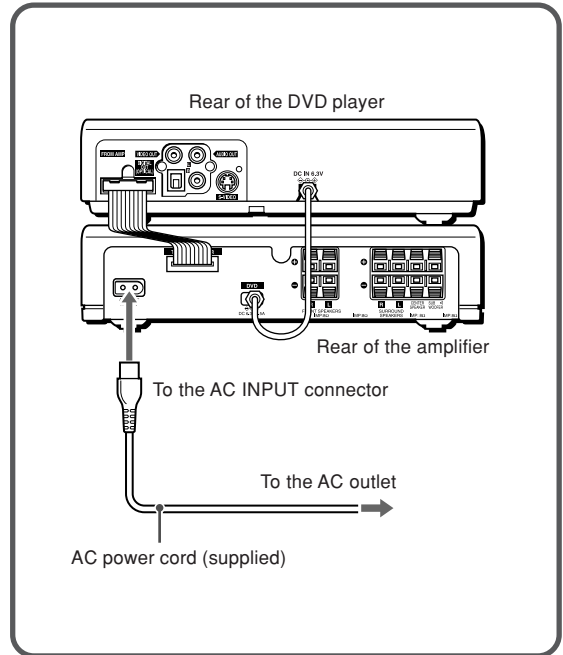

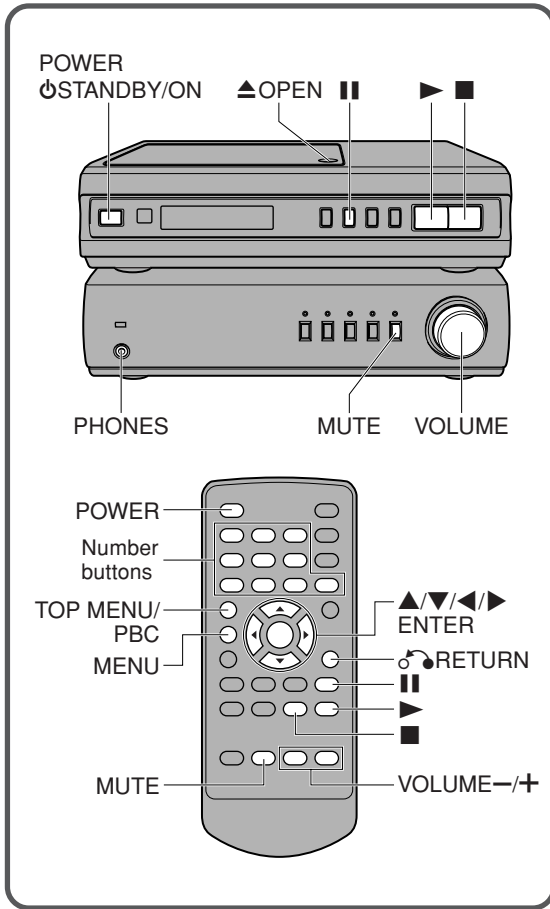

The POWER/STANDBY indicator lights up red and the system enters power-off standby mode, when the AC power cord is connected to the AC outlet.

PLAYBACK



About the symbol display

- The  symbol will be displayed on the TV screen if you press a button which cannot be used or enter an incorrect number.
- Some DVDs may have places where they do not allow pressing certain buttons. The  symbol will be displayed on the TV screen if you press a button that is not allowed in such a place.

Getting ready to play

- Turn on the television, and set its video source (Video 1, Video 2, Video 3, etc.) to the one connected to the system.
- Turn on the audio equipment connected to the system. Set its input source to the one connected to the system.

1 Press POWER (STANDBY/ON).

The system turns on and the POWER/STANDBY indicator lights up green. "aiwa" appears on the TV screen.

2 Press OPEN to open the disc cover.

"OPEN" appears on the display window.

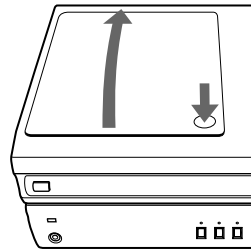

3 Load a disc with the label side up and push around the center of it.

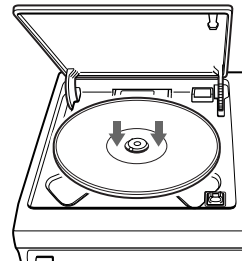
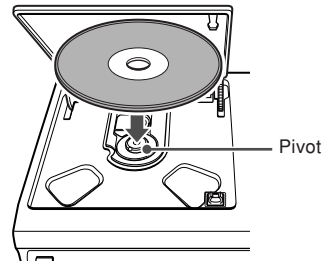

The disc clicks into position.

4 Close the disc cover.

- When a DVD or video CD is loaded, playback starts automatically.
- If an audio CD is loaded, press . Playback starts and On-Screen Display (OSD) menu is automatically displayed on the TV screen. For details about the OSD menu, see page 23.

NOTE

Do not move or lift the system while a disc is rotating inside.

When the menu screen is displayed

The menu screen may be displayed first after loading a DVD or video CD which contains a menu.

Menu settings and the exact operating procedures for using the menu differ depending on the disc. Follow the instructions on each menu screen.

DVD

Use ▲/▼/◀/▶ or the number buttons to select the program you want to view, then press **ENTER** or ▶ to start playback. Press **TOP MENU/PBC** or **MENU** to return to the menu screen.

VCD2.0

Use the number buttons and press **ENTER** to start playing the program you want to view. Press ◀ **RETURN** or **MENU** to return to the menu screen.

When PBC is turned off, you can play the disc continuously without returning to the menu screen. To turn off PBC, see "Playing a video CD without using Playback Control (PBC)" on page 20.

To stop playback

Press ■.

To turn the power off

Press **POWER** (⏻ **STANDBY/ON**).

The system enters power-off standby mode. "OFF" appears on the display window.

If 20 minutes have elapsed without any operation

The system automatically enters power-off standby mode.

Removing the disc

- 1 Press ■ to stop play.
If a DVD or video CD without PBC has been played, press ■ once again.
- 2 Press ▲ **OPEN** to open the disc cover.
- 3 Wait until the rotating disc is completely stopped.
- 4 Pull out the disc while pressing the center pivot.
Do not touch the surface of the disc.
- 5 Close the disc cover.

NOTE

Do not open the disc cover during playback.

Adjusting the volume

Turn the **VOLUME** control on the amplifier or press **VOLUME -/+** on the remote control during playback. The volume can be adjusted between 0 (minimum) and 40 (maximum).

During volume adjustment, the volume level is displayed on the TV screen.

Example: When the volume level is 25



"25" is also displayed on the display window of the DVD player.

The volume level setting is retained during power-off standby. If the system is turned off with the volume level set to 11 or more, it is automatically turned down to 10 the next time the system is turned on.

To turn off the audio temporarily

Press **MUTE** on the amplifier or on the remote control. The volume level becomes 0 and the **MUTE** indication and the previous volume level are displayed on the TV screen.

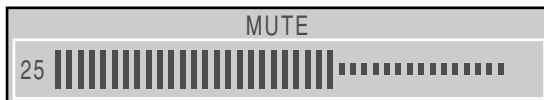

To restore the audio to the previous volume level, press **MUTE** again.

For private listening

Connect an optional headphones set with a stereo mini plug (3.5-mm diameter) to the **PHONES** jack on the amplifier.

The speaker output is turned off.

PLAYBACK (CONTINUED)

Resuming playback

DVD VCD1.1

The system remembers the point where you stopped the disc so that you can resume playback from that point.

Press ► in stop mode.

To clear the resume point

Press ■ again after you stop the disc. "RESUME OFF" appears briefly on the TV screen and the resume point is cleared.

The resume point is also cleared when you open the disc cover.

NOTES

- The disc is rotating even in stop mode while the resume function is on.

VCD2.0

- To resume playback from the point where you stopped, turn off PBC first. See "Playing a video CD without using Playback Control (PBC)" on page 20.

Still (pause)

Press || during playback.

The time counter on the display window flashes when playing a DVD, audio CD or video CD without PBC.

To return to normal playback

Press ►.

CD

You can also press || to return to normal playback.

Frame advance

DVD VCD2.0 VCD1.1

Press || during pause.

Each time the button is pressed, the picture advances one frame.

To return to normal playback

Press ►.

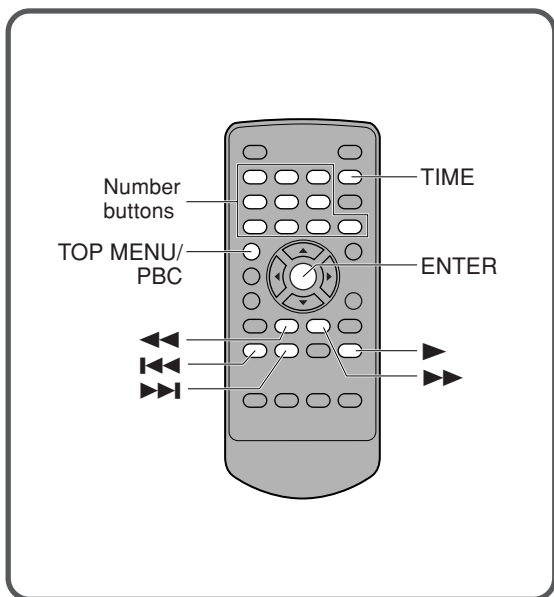

Each time you press ◀◀ or ▶▶, the play speed changes as shown below.

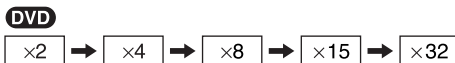

- If you press ◀◀ while fast forwarding or ▶▶ while fast reversing a DVD or video CD, the play speed lowers one step in the respective direction.
- If you press ◀◀ while fast forwarding or ▶▶ while fast reversing a DVD or video CD at the lowest speed of ×2, fast playback changes its direction to the opposite with the speed ×2.
- The play speed returns to normal at the beginning or end of the track when fast forwarding or fast reversing a video CD.

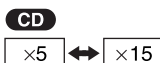

If you press ◀◀ while fast forwarding or ▶▶ while fast reversing an audio CD, fast playback changes its direction to the opposite with the speed ×5.

If you hold down ◀◀ or ▶▶ on the DVD player during playback, the system starts fast forward or fast reverse at the following fixed speed.



There is no audio during fast forward or fast reverse except for audio CDs.

To return to normal playback

Press ▶.

NOTES

DVD VCD2.0

- Slow playback, fast forward or fast reverse may be canceled when:
 - the title has been changed.
 - playback has reached the end of a branch menu or the system returned to the main menu.

VCD2.0

- Performing fast forward or fast reverse with PBC on may cause the system to return to the menu screen.

Slow playback

DVD VCD2.0 VCD1.1

Press ▶▶ during pause.

Each time the button is pressed, the play speed changes as shown below.



There is no audio during slow playback.

When you press ◀◀ during slow playback

Each time the button is pressed, the play speed lowers one step.

Pressing ◀◀ at 1/30 causes the system to pause.

When pressing ◀◀ during still (pause), fast reverse starts at the ×2 speed.

To return to normal playback

Press ▶.

Fast forward/fast reverse

To fast forward a disc

Press ▶▶ during playback.

To fast reverse a disc

Press ◀◀ during playback.

CONTINUE

PLAYBACK (CONTINUED)

Skipping

To skip to the next chapter or track

Press **▶▶** during playback.
The disc position advances one chapter or track each time the button is pressed.

To return to the previous chapter or track

Press **◀◀** during playback to return to the beginning of the chapter or track currently being played.

Press **◀◀** twice in rapid succession to return to the beginning of the previous chapter or track.

NOTES

VCD2.0

- When you press **◀◀** during playback with PBC on, you are only returned to the beginning of the track currently being played.
- Skipping with PBC on may cause the system to return to the menu screen.

To skip to the desired track directly using the number buttons

VCD1.1 CD

During playback or in stop mode, enter the desired track number using the number buttons.

Example: To play track 3,
press **3** and then **ENTER**.
To play track 20,
press **2, 0** and then **ENTER**.

Playback starts from the beginning of the selected track.

Checking the play time during playback

Press TIME during playback.

The current play time is displayed on the TV screen for 10 seconds.

Each time the button is pressed, the play time displayed on the TV screen and on the display window changes as follows:

DVD

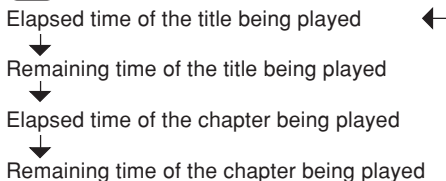

VCD1.1

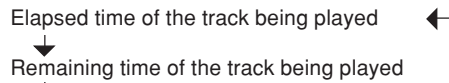

CD

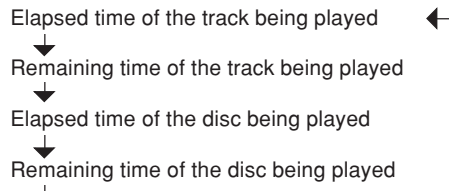

NOTES

CD

- During programmed playback, "TOTAL" is displayed instead of "DISC" in the TIME field on the TV screen.

VCD2.0

- When PBC is turned on, "PbC" is displayed continuously on the display window instead of play time even if you press **TIME**. To turn off PBC, see "Playing a video CD without using Playback Control (PBC)" below.

Playing a video CD without using Playback Control (PBC)

VCD2.0

The system can switch on and off the PBC (Playback Control) function. When PBC is turned off, the video CD version 2.0 is played the same as a video CD version 1.1 which does not have menu operation capabilities.

Press TOP MENU/PBC.

"PbC" disappears from the display window and the menu playback feature is disabled.

Playback stops when **TOP MENU/PBC** is pressed during playback.

To turn on PBC

Press **TOP MENU/PBC** again.

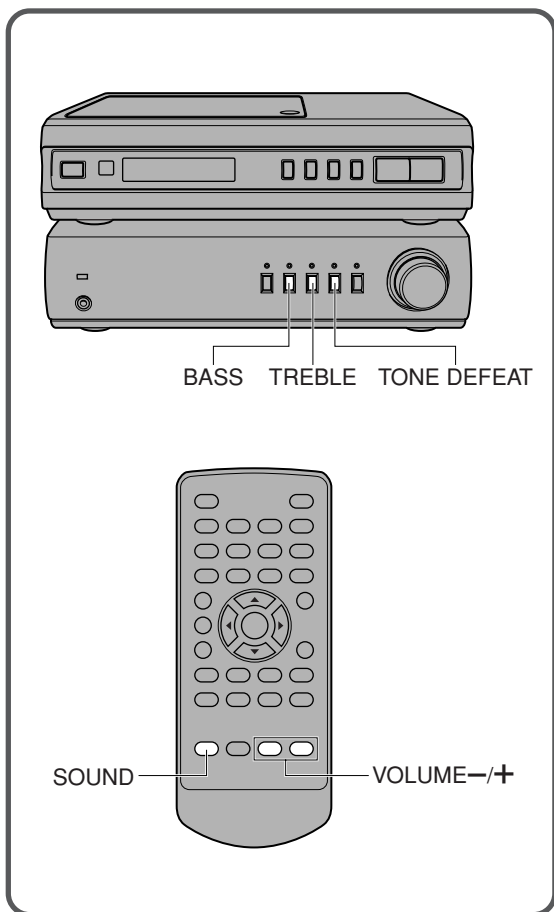

Sound adjustment

You can adjust sound to your taste by emphasizing low frequencies and/or high frequencies.

1 Press **SOUND** repeatedly.

Each time the button is pressed, the "BASS", "TREBLE" or "TONE DEFEAT" level indication appears in turn on the TV screen.

Select "BASS" to emphasize low frequencies or "TREBLE" to emphasize high frequencies.

Alternatively, press **BASS** or **TREBLE** on the amplifier.

Example: "BASS" level indication

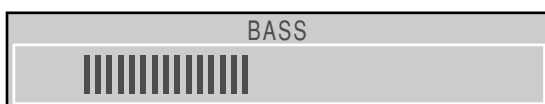

2 Within 4 seconds, press **VOLUME -/+**.

Each time the button is pressed, the bass or treble level increases or decreases by one step. The level can be adjusted between 1 (no emphasis) and 7 (maximum emphasis).

Alternatively, press **BASS** or **TREBLE** repeatedly on the amplifier.

To cancel bass/treble emphasis temporarily

Press **SOUND** repeatedly to select "TONE DEFEAT", then press **VOLUME -/+** to select "ON".

Alternatively, press **TONE DEFEAT** on the amplifier to select "ON".



To restore the bass/treble emphasis to the previous levels, select "TONE DEFEAT" again and "OFF" by pressing **SOUND** and **VOLUME -/+** on the remote control.

Alternatively, press **TONE DEFEAT** on the amplifier to select "OFF".

PLAYBACK (CONTINUED)

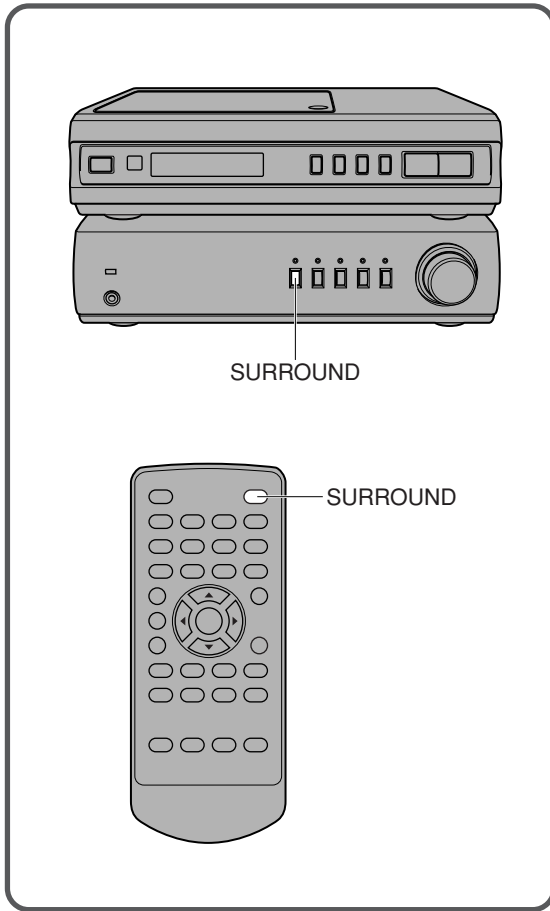

Creating a simulated audio surround effect

The system provides three audio surround modes that you can select when listening to two-channel sources.

Press **SURROUND** repeatedly.

Each time the button is pressed, the audio surround mode changes as follows:



HALL: produces a surround effect as if you were in a concert hall.

STADIUM: the reverberation time is much delayed to produce an echo effect as if you were in a large stadium.

LIVE: the reverberation time is relatively short so that you can feel as though you were in a small music hall.

OFF (no indication): turns off the audio surround effect.

NOTES

- The audio surround effect only functions when the SURROUND L/R speakers are connected to the system.
- With some discs, the audio surround effect may not work or may even produce an adverse acoustic effect on sound reproduction. In this case, turn off the audio surround effect.

Basic operation of the On-Screen Display (OSD) menu

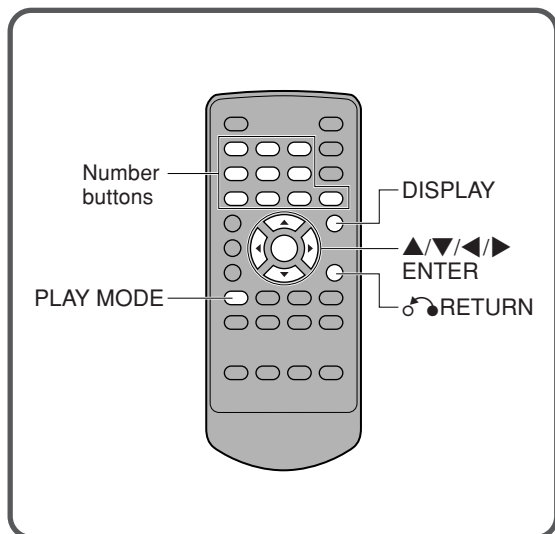

You can check the general playback status, change the play mode or locate a desired point on the disc, etc. by displaying and operating the OSD menu.

When playing an audio CD, the OSD menu is displayed without pressing **DISPLAY** allowing you to skip step 1 below.

1 Press **DISPLAY**.

The 1st (partial) display or 2nd (full) display of the OSD menu appears on the TV screen. → Go to step 2 if you want to display the 2nd (full) OSD menu. Otherwise, go to step 3.

The menu items differ depending on the disc type. See "Example On-Screen Display (OSD) menu" on page 24.

2 Press **▲/▼** repeatedly to move the cursor (blue area) to the top or bottom item of the 1st (partial) OSD menu, then press **▲/▼** again.

The 2nd (full) display of the OSD menu appears on the TV screen.

3 Press **▲/▼** repeatedly to select the desired menu item, then press **ENTER** or the **▶** right cursor button.

The  symbol will be displayed if you press **ENTER** or the **▶** right cursor button at a menu item whose operation is prohibited.

4 Press **▲/▼** repeatedly to select the desired setting.

The number buttons can also be used for entering numbers (e.g. title number).

5 Press **ENTER**.

The new setting is confirmed.

Some menu items require further settings. In such a case repeat steps 4 and 5.

To return to the previous menu screen

Press  **RETURN** or **◀**.

To turn off the OSD menu

Press **DISPLAY**.

Tip

About the **PLAY MODE** button

The **PLAY MODE** button can also be used instead of **DISPLAY** to display the following OSD menu items: TITLE/TRACK, CHAPTER, TIME, REPEAT and PROGRAM.

To display the OSD menu using the **PLAY MODE** button

Press **PLAY MODE**, then follow steps 3 through 5 above. If you do not press **▲/▼** within 10 seconds after pressing **PLAY MODE**, the OSD menu disappears and the operation is canceled.

To turn off the OSD menu, press **PLAY MODE** again.

PLAYBACK (CONTINUED)

Example On-Screen Display (OSD) menu (fully displayed)

DVD

TITLE	01 / 10
CHAPTER	1 / 2
TIME	TITLE 0 : 01 : 47
AUDIO	2 / 3 DolbyDigital
SUBTITLE	
ANGLE	
REPEAT	OFF
ZOOM	
MARK	* * * * *

VCD2.0 VCD1.1

TRACK	03 / 11
TIME	TRACK 0 : 09 : 16
AUDIO	STEREO
REPEAT	OFF
PROGRAM	OFF
ZOOM	
MARK	* * * * *

CD

TRACK	01 / 10
TIME	TRACK 0 : 01 : 58
AUDIO	STEREO
REPEAT	OFF
PROGRAM	OFF

NOTE

VCD2.0

When playing a video CD with PBC on, the status/setting fields of the TRACK, TIME, REPEAT, PROGRAM and MARK menu items are blank (no indication).

Description of each OSD menu item

Each menu item shows its current status/setting, which can be changed in the OSD menu. For details of the functions or optional settings, refer to the pages in parentheses.

DVD

First (partial) display

Menu item	Status/setting	Function
TITLE	<ul style="list-style-type: none"> Title number/total number of titles Total number of titles in stop mode (resume off) 	Skip to the desired title. (Title search on page 26)
CHAPTER	Chapter number/total number of chapters	Skip to the desired chapter. (Chapter search on page 27)
TIME	Elapsed time or remaining time of title/chapter	Skip to the desired time point. (Time search on page 27)



Press ▲ when the cursor (blue area) is at the top item "TITLE".
Press ▼ when the cursor is at the bottom item "TIME".

Second (full) display

AUDIO	<ul style="list-style-type: none"> Audio track number/total number of audio tracks Soundtrack language Encoding method 	Change the audio track. (page 35)
SUBTITLE	<ul style="list-style-type: none"> Subtitle language Subtitle on/off 	Change the settings. (page 36)
ANGLE	Angle number/total number of angles	Change the angle. (page 34)
REPEAT	Repeat play mode	Start repeat playback. (page 32)
ZOOM	—	Turn on/off the zoom function. (page 34)
MARK	Mark entry	Store/search mark points. (page 28)

VCD2.0 VCD1.1**First (partial) display**

Menu item	Status/setting	Function
TRACK *	<ul style="list-style-type: none"> Track number/total number of tracks Total number of tracks in stop mode (resume off) 	Skip to the desired track. (Track search on page 26)
TIME *	Elapsed time or remaining time of track	Skip to the desired time point within a track. (Time search on page 27)



Press ▲ when the cursor (blue area) is at the top item "TRACK".
Press ▼ when the cursor is at the bottom item "TIME".

Second (full) display

AUDIO	Audio channel number/total number of audio channels	Change the audio channel. (page 35)
REPEAT *	Repeat play mode	Start repeat playback. (page 32)
PROGRAM *	Program or random play mode	<ul style="list-style-type: none"> Edit program. Start random or programmed playback. (pages 29, 30)
ZOOM	—	Turn on/off the zoom function. (page 34)
MARK *	Mark entry	Store/search marked points. (page 28)

* No indication for the status/setting field and the function for the menu item is always disabled with video CDs version 2.0 with PBC on.

CD**First (partial) display**

Menu item	Status/setting	Function
TRACK	<ul style="list-style-type: none"> Track number/total number of tracks Total number of tracks in stop mode 	Skip to the desired track. (Track search on page 26)
TIME	<ul style="list-style-type: none"> Elapsed time or remaining time of disc/track Total play time of disc in stop mode 	Skip to the desired time point. (Time search on page 27)



Press ▲ when the cursor (blue area) is at the top item "TRACK".
Press ▼ when the cursor is at the bottom item "TIME".

Second (full) display

AUDIO	"STEREO" indication	—
REPEAT	Repeat play mode	Start repeat playback. (page 32)
PROGRAM	Program or random play mode	<ul style="list-style-type: none"> Edit program. Start random or programmed playback. (pages 29, 30)

SEARCH

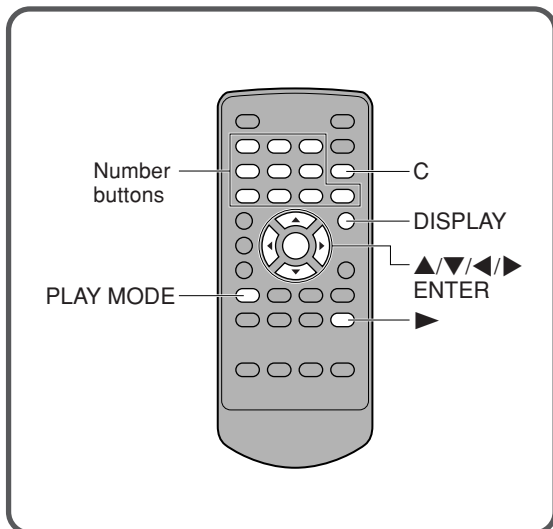

The system provides four search functions.

DVD VCD1.1 CD

Title search/Track search

Locates a desired title or track.

DVD

Chapter search

Locates a desired chapter.

DVD VCD1.1 CD

Time search

Locates a desired time point.

DVD VCD1.1

Mark search

Locates a marked point.

NOTE

VCD2.0

The track, time and mark search functions do not work unless you turn off PBC first. See "Playing a video CD without using Playback Control (PBC)" on page 20.

Title search/track search

DVD VCD1.1 CD

1 Press DISPLAY or PLAY MODE.

The OSD menu appears on the TV screen. For details on how to operate the OSD menu, see "Basic operation of the On-Screen Display (OSD) menu" on page 23.

2 Press ▲/▼ repeatedly to select "TITLE" or "TRACK", then press ENTER or the ► right cursor button.

When you pressed **PLAY MODE** and if you do not press ▲/▼ within 10 seconds, the OSD menu disappears and the operation is canceled.

The cursor (yellow area) is now at the title/track number input field.

DVD

TITLE	0 / 2
CHAPTER	1 / 8
TIME	TITLE 0 : 03 : 39

VCD1.1 CD

TRACK	00 / 10
TIME	TRACK 0 : 50 : 18

3 Press ▲/▼ repeatedly to enter the desired title/track number.

Alternatively, use the number buttons.

Example: To enter title/track number 2, press 2.
To enter title/track number 12, press 1 and then 2.

If you enter a wrong number

Press **C** and enter the correct number.

4 Press ENTER or ►.

Playback starts from the selected title/track.

Chapter search

DVD

1 Press DISPLAY or PLAY MODE.

The OSD menu appears on the TV screen. For details on how to operate the OSD menu, see "Basic operation of the On-Screen Display (OSD) menu" on page 23.

2 Press ▲/▼ repeatedly to select "CHAPTER", then press ENTER or the ► right cursor button.

When you pressed **PLAY MODE** and if you do not press ▲/▼ within 10 seconds, the OSD menu disappears and the operation is canceled.

The cursor (yellow area) is now at the chapter number input field.

TITLE	1 / 2
CHAPTER	00 / 16
TIME	TITLE 0 : 28 : 15

3 Press ▲/▼ repeatedly to enter the desired chapter number.

Alternatively, use the number buttons.

Example: To enter chapter number 2, press **2**.
To enter chapter number 12, press **1** and then **2**.

If you enter a wrong number
Press **C** and enter the correct number.

4 Press ENTER or ►.

Playback starts from the selected chapter.

NOTE

Chapter search does not work on DVDs with no chapters recorded.

Time search

DVD VCD1.1 CD

1 Press DISPLAY or PLAY MODE .

The OSD menu appears on the TV screen. For details on how to operate the OSD menu, see "Basic operation of the On-Screen Display (OSD) menu" on page 23.

2 Press ▲/▼ repeatedly to select "TIME", then press ENTER or the ► right cursor button.

When you pressed **PLAY MODE** and if you do not press ▲/▼ within 10 seconds, the OSD menu disappears and the operation is canceled.

The cursor (yellow area) is now at the time input field.

TITLE	00 / 10
CHAPTER	1 / 2
TIME	0 : 00 : 00

3 Use the number buttons to enter the desired time point on the disc.

Example: To start playback at 1 hour, 17 minutes, 30 seconds (1:17:30), press **1**, **1**, **7**, **3** and then **0**.
To start playback at 8 minutes 7 seconds (0:08:07), press **8**, **0** and then **7**.

If you entered wrong numbers
Press **C** repeatedly to cancel the numbers. Then enter the correct numbers.

4 Press ENTER or ►.

Playback starts from the specified time point.

NOTES

- Time search does not work if you specify a time longer than the length of the disc.
- Time search may not work with some discs even if the elapsed time is displayed.
- Time search works only within the same track while playing back a video CD.

CONTINUE

SEARCH (CONTINUED)

Mark search

DVD VCD1.1

Up to five points can be stored as marked points for a disc and you can specify a desired marked point to start playback.

1 Press **DISPLAY** during playback.

The OSD menu appears on the TV screen.

For details on how to operate the OSD menu, see "Basic operation of the On-Screen Display (OSD) menu" on page 23.

2 Press **▲/▼** repeatedly to select "MARK", then press **ENTER** or the **▶** right cursor button.

The cursor (yellow area) is now at the first "*" of the mark entry field.



3 Press **ENTER** at a desired point.

Each time a point is marked, "*" changes to a mark number "1" to "5".

4 Press the **▶** right cursor button.

The cursor (yellow area) moves to the next "*".

5 Repeat steps 3 and 4 to mark other points.



To start playback from a desired marked point

In the mark entry field, press **◀/▶** repeatedly or use the number buttons (1 - 5) to select a desired marked point, then press **ENTER** or **▶**.

To clear a marked point

In the mark entry field, press **◀/▶** repeatedly or use the number buttons (1 - 5) to select the marked point you want to clear, then press **C**.

NOTES

- During programmed playback, the mark search function does not work.
- With some discs, playback may not start from the specified marked point.

RANDOM PLAYBACK

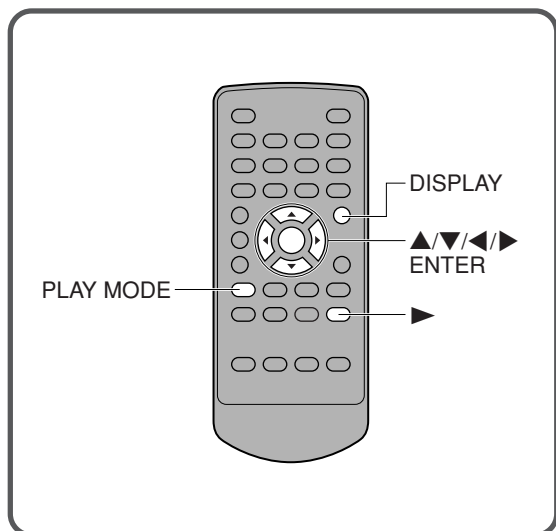

VCD1.1 CD

1 Press DISPLAY or PLAY MODE.

The OSD menu appears on the TV screen.
For details on how to operate the OSD menu, see "Basic operation of the On-Screen Display (OSD) menu" on page 23.

2 Press ▲/▼ repeatedly to select "PROGRAM", then press ENTER or the ► right cursor button.

When you pressed **PLAY MODE** and if you do not press ▲/▼ within 10 seconds, the OSD menu disappears and the operation is canceled.

3 Press ▲/▼ repeatedly to select "RANDOM", then press ► or ENTER.

The system starts playing the tracks in random order.

To cancel random playback

In step 3, press ▲/▼ repeatedly to select "OFF", then press **ENTER**.

NOTE

VCD2.0

This function does not work unless you turn off PBC first. See "Playing a video CD without using Playback Control (PBC)" on page 20.

6 Repeat steps 4 and 5 to program other tracks.

The program list can contain a total of 99 tracks on 4 pages. Press ◀◀/▶▶ to go to the previous or next page.

OSD on the TV screen

Display window of the system

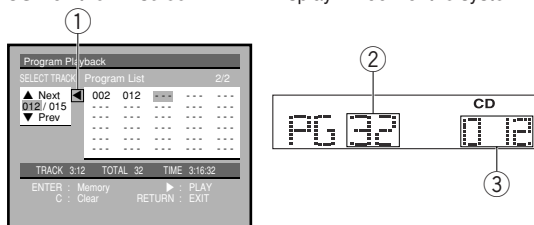

- ① Scroll mark indicating there is a previous page
- ② Total number of tracks on the program list
- ③ Track number currently selected

7 Press ▶.

Playback starts in the programmed order.

You can repeat playing a track or all tracks in the program. For details, see "Repeat playback" on page 32.

To cancel programmed playback

In step 3, press ▲/▼ repeatedly to select "OFF", then press ENTER.

Modifying the program

1 Follow the procedure of steps 1 and 2 in "Programming tracks" on page 30.

2 Press ▲/▼ repeatedly to select "EDIT", then press ENTER.

The program list menu appears on the TV screen.

3 Edit the program as required.

To add a track to the program list

1 Press ▲/▼ repeatedly or use the number buttons to select a desired track.

For how to enter a track number using the number buttons, see step 4 in the previous page.

2 On the program list, press ◀/▶ to position the cursor where you want to add the track.

3 Press ENTER.

The track is added to the program list. All the subsequent tracks including the one at which you positioned the cursor are shifted back by one position.

To delete a track from the program list

On the program list, press ◀/▶ repeatedly to select an unwanted track, then press C.

The selected track is deleted. All the subsequent tracks are shifted forward by one position.

Clearing the entire program

1 Follow the procedure of steps 1 and 2 in "Programming tracks" on page 30.

2 Press ▲/▼ repeatedly to select "ALL CLEAR", then press ENTER.

The program is cleared.

NOTE

"ALL CLEAR" is not displayed when there is no program.

REPEAT PLAYBACK

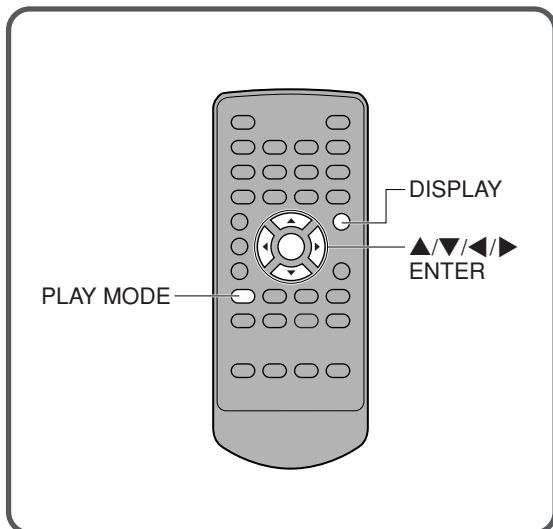

NOTE

VCD2.0

This function does not work unless you turn off PBC first. See "Playing a video CD without using Playback Control (PBC)" on page 20.

Repeat playback

DVD VCD1.1 CD

1 Press DISPLAY or PLAY MODE during playback.

The OSD menu appears on the TV screen. For details on how to operate the OSD menu, see "Basic operation of the On-Screen Display (OSD) menu" on page 23.

2 Press ▲/▼ repeatedly to select "REPEAT", then press ENTER or the ► right cursor button.

When you pressed **PLAY MODE** and if you do not press ▲/▼ within 10 seconds, the OSD menu disappears and the operation is canceled.

3 Press ▲/▼ repeatedly to select the desired repeat mode.

Each press of ▲/▼ changes the repeat mode as follows.

DVD

OFF:

Cancels repeat playback (normal playback).

REPEAT OFF



A-B:

Repeats a section between two specified points on the disc.

REPEAT A-B



TITLE:

Repeats the title currently being played.

REPEAT TITLE



CHAPTER:

Repeats the chapter currently being played.

REPEAT CHAPTER

NOTES

- "REPEAT A-B" is not displayed in stop mode.
- The chapter repeat function does not work on DVDs with no chapters recorded.

VCD1.1 CD

OFF:

Cancels repeat playback (normal playback).



A-B:

Repeats a section between two specified points on the disc.



DISC:

Repeats all tracks on the disc.



TRACK:

Repeats the track currently being played.



NOTES

- "REPEAT A-B" is only displayed during normal playback.
- "PROGRAM" is displayed instead of "DISC" during programmed playback.
- Program repeat mode and track repeat mode are selectable during programmed playback; and disc repeat mode is selectable during random playback.
- Activating track repeat mode during random playback turns off random play mode.

4 Press ENTER.

- **When you selected A-B repeat mode in step 3**
Go to step 2 of the next section "Repeating a section between two specified points (A-B repeat)".
- **When you selected a repeat mode other than A-B repeat mode in step 3**
The system starts repeat playback in the selected mode.

To cancel repeat playback

Press ▲/▼ repeatedly to select "OFF" in step 3, then press **ENTER**.

The selected repeat mode is retained until the system is turned off or the disc is removed.

Repeating a section between two specified points (A-B repeat)

DVD VCD1.1 CD

1 Select "A-B" in step 3 of the previous section "Repeat playback".

2 Press **ENTER** at the desired start point (A) of the section you want to repeat.



3 Press **ENTER** again at the desired end point (B).

The system returns to point A and plays the section between A and B repeatedly.



To cancel A-B repeat playback

Press ▲/▼ repeatedly to select "OFF" in step 3 of "Repeat playback", then press **ENTER**.

- Pressing **◀◀/▶▶** to select a chapter/track cancels A-B repeat playback.
- Entering random or program play mode also cancels A-B repeat playback.

NOTES

- If the section between A and B is less than a few seconds, the A-B repeat play function may not work.
- A-B repeat mode is not selectable during programmed or random playback.

VCD1.1

- The A-B repeat play function works only when A and B points fall within the same track.

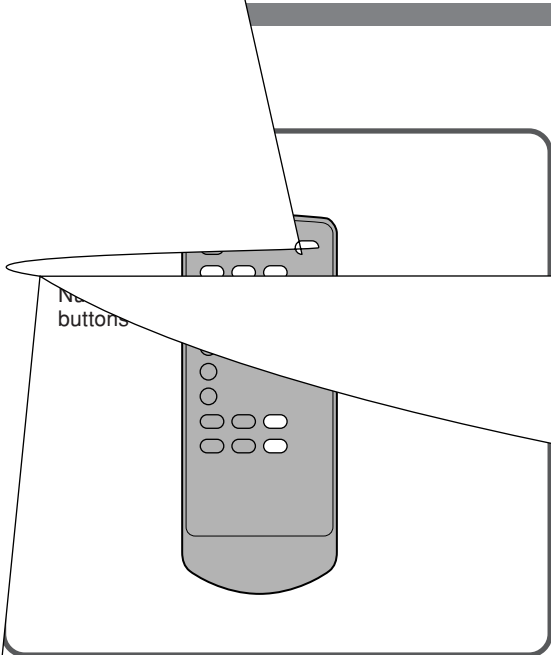

Changing the angle

DVD
When playing a DVD with multi-angle scenes (photographed from several different angles), you can select

Tip
The total number of angles recorded on a DVD appears on its case within the following angle symbol.



Zooming the picture

DVD VCD2.0 VCD1.1
This function allows you to zoom in and enlarge the picture to 4 times.

1 Press DISPLAY during playback.

The OSD menu appears on the TV screen. For details on how to operate the OSD menu, see "Basic operation of the On-Screen Display (OSD) menu" on page 23.

2 Press ▲/▼ repeatedly to select "ZOOM", then press ENTER or the ► right cursor button.

"ZOOM" appears on the TV screen for a few seconds. The picture around the center is enlarged to four times.

To move the zoom area

Press ▲/▼/◀/▶.
To return to the center, press C.

To cancel the zoom function

Press ENTER.

NOTES

- DVD**
- The zoom function may not work with some DVDs.
- The zoom function may not work on multi-angle scenes.

1 Press DISPLAY during playback.

The OSD menu appears on the TV screen. For details on how to operate the OSD menu, see "Basic operation of the On-Screen Display (OSD) menu" on page 23.

2 Press ▲/▼ repeatedly to select "ANGLE", then press ENTER or the ► right cursor button.

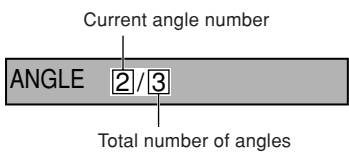

3 Press ▲/▼ repeatedly to select the desired angle number.

Alternatively, use the number buttons.

NOTES

- The symbol appears if you press ENTER or ► in step 2 during playback of a disc with no multi-angle scenes, or at a scene where the angle cannot be changed.
- While the zoom function is active, the angle cannot be changed.
- The mark search, chapter repeat and A-B repeat functions do not work on multi-angle scenes.

CHANGING THE AUDIO TRACK

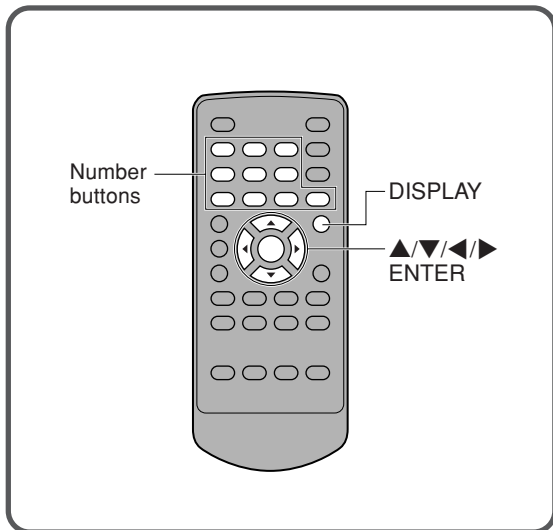

DVD VCD2.0 VCD1.1

Some discs have more than one audio track, such as soundtracks with different languages. While playing such a disc, the audio track can be changed to play different soundtracks.

- When playing a DVD with soundtracks in multiple languages, the audio will automatically be played in the language designated in the setup menu (page 43). If that language is not on the disc, the original language for the disc is selected.
- The audio track may only be changed with discs which contain multiple audio tracks.
- The number of audio tracks available differs from disc to disc.

Tip

The total number of soundtracks recorded on a DVD usually appears on its case within the following symbol.



1 Press DISPLAY during playback.

The OSD menu appears on the TV screen. For details on how to operate the OSD menu, see "Basic operation of the On-Screen Display (OSD) menu" on page 23.

2 Press ▲/▼ repeatedly to select "AUDIO", then press ENTER or the ► right cursor button.

3 Press ▲/▼ repeatedly to select the desired audio track number or audio channel.

You can also use the number buttons to select an audio track number.

DVD

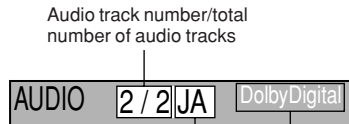

Soundtrack language

DVD KARAOKE

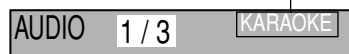

VCD2.0 VCD1.1



NOTE

Depending on the disc, the system may play only the original language for the disc even if the disc contains multiple-language soundtracks.

DISPLAYING AND CHANGING SUBTITLES

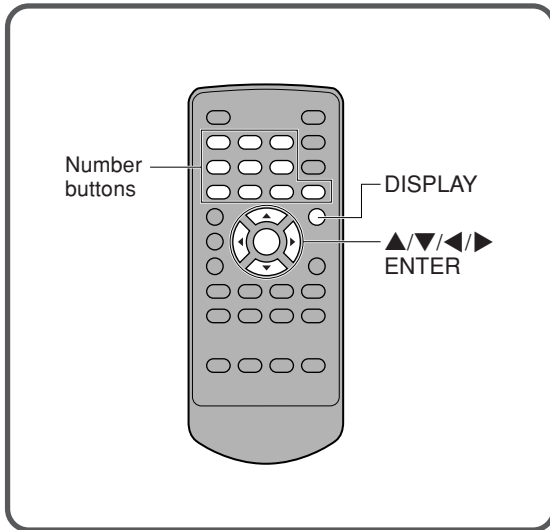

DVD

When playing DVDs which contain subtitles, you can turn on and off the subtitle display on the TV screen and change the subtitle language.

- The subtitle is displayed in the language designated in the setup menu (page 44). If that language is not on the disc, the original language for the disc is selected.
- The subtitle language may only be changed with discs which contain more than one set of subtitles.
- The number of subtitle languages differs depending on the disc.

Tip

The total number of subtitle languages recorded on a DVD usually appears on its case within the following symbol.



1 Press DISPLAY during playback.

The OSD menu appears on the TV screen. For details on how to operate the OSD menu, see "Basic operation of the On-Screen Display (OSD) menu" on page 23.

2 Press ▲/▼ repeatedly to select "SUBTITLE", then press ENTER or the ► right cursor button.

Subtitle number/total number of subtitle sets

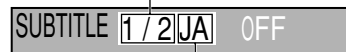

Subtitle language

3 Press ▲/▼ repeatedly to select the desired subtitle number.

Alternatively, use the number buttons.

4 Press the ► right cursor button.

5 Press ▲/▼ to turn on or off the subtitle display.

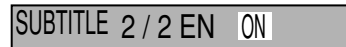

NOTE

Depending on the disc, the system may display only the subtitles in the language designated for the disc even if the disc contains more than one set of subtitles.

PLAYING AN MP3 DISC **MP3**

The system can play MP3 audio recorded on CD-ROM, CD-R or CD-RW discs.

Before playing an MP3 disc, read the following notes.

Notes on MP3 discs

An MP3 file stores audio data compressed using MPEG 1/2, the audio layer-3 file-coding scheme.

In this manual, we refer to what, in PC terminology, are called "folders" and "files" as "albums" and "tracks" respectively.

Notes on playing MP3 discs

- An MP3 track must be recorded on a disc in the format compliant with ISO 9660. Note however, that the system may not play tracks in the order they were recorded.
- The maximum allowable number of tracks and/or albums in a disc is 255, including the root albums (directory).
- The maximum allowable depth of a nested folder is 8, including tracks. Note that since the maximum path length is 128 characters long, the total number of characters including slashes, hyphens and underscores from the root album name to the track name must be less than 128.
- If a disc contains audio tracks and MP3 tracks, the system can only play audio tracks.
- The system may not play multi-session discs correctly.
- The system can play only MP3 tracks which were converted with a sampling frequency of 44.1 kHz and a fixed or variable bit rate.
- The system may not play MP3 tracks recorded using a packet writing utility.
- The system can play only MP3 tracks having the file extension ".mp3".
- It may take 30 seconds or more before the system can start playback of MP3 tracks, depending on the number of recorded tracks and the complexity of the album tree.
- If you play a non-MP3 track that has the ".mp3" file extension, you may hear some noise.

Notes on display indications during playback

- Up to 30 characters are displayed for the name of an album and up to 30 characters for the name of track.
- Characters other than letters ("A" to "Z" and "a" to "z"), numerals ("0" to "9"), hyphen (-) and underscore () may not be displayed, or may be displayed as different characters.
- The system does not support ID3TAG.
- The elapsed play time may not be displayed correctly for MP3 tracks.

Notes on creating MP3 discs

- When converting audio data to MP3
Creating MP3 files with a sampling frequency of 44.1 kHz and a fixed bit rate of 128 kbps is recommended.
- When creating MP3 discs
Do not store more than 255 albums and/or tracks in a disc.
- To play tracks in the order they were recorded
 1. Use writing software capable of recording MP3 tracks (files) in numerical and alphabetical order. For details, refer to the operating instructions supplied with the software.
 2. Use only one album. (Do not create a sub-album within an album.)
 3. Include a two or three-digit number at the beginning of each album or track name which complies with ISO 9660 Level 2 or the Windows JOLIET format so that the albums and tracks are played in order.
<Example of recommended name structure>
01XXXXX.mp3
02XXXXX.mp3
03XXXXX.mp3
04XXXXX.mp3
05XXXXX.mp3
<Avoid using the following structure>
1XXXXX.mp3
5XXXXX.mp3
10XXXXX.mp3
15XXXXX.mp3
20XXXXX.mp3
(The beginning numbers determine the order, therefore the tracks shown above will be played in the wrong order, i.e., "1", "10", "15", "20", and "5".)

Glossary

File extension:

A 3-character string added to a file name under the Windows or DOS environment is called a "file extension". The file extension is used mainly to identify types of files. The file extension for MP3 files is ".mp3".

ISO 9660:

ISO stands for the "International Organization for Standardization". ISO 9660 determines the file structure for the CD-ROMs. This system can play MP3 files recorded in the format compliant with ISO 9660.

Nesting of folders (albums):

To organize data files stored in a PC, you can store related files in a folder. A folder can contain other folders as well as files. For example, folder A can contain folder B, and folder B can contain folder C; this is called "nesting of folders".

Session:

A session is one uninterrupted section of written data on a disc.

A multi-session disc is a disc which has two or more sessions.

PLAYING AN MP3 DISC (CONTINUED)

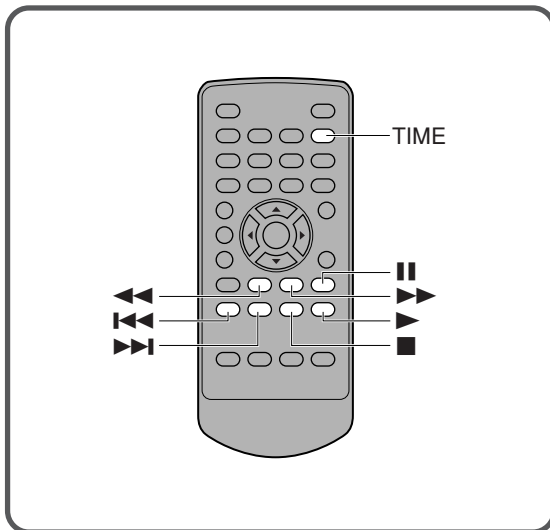

The following functions do not work when playing an MP3 disc.

- Sound reproduction during fast forward or fast reverse
- Time search
- Audio channel selection

Playing an MP3 disc

1 Load an MP3 disc.

"MP3" lights up and the total number of tracks is displayed on the display window.

It may take over 30 seconds to read the MP3 tracks depending on the complexity of the album tree.

2 Press ►.

Playback starts.
Disc information is displayed on the TV screen.

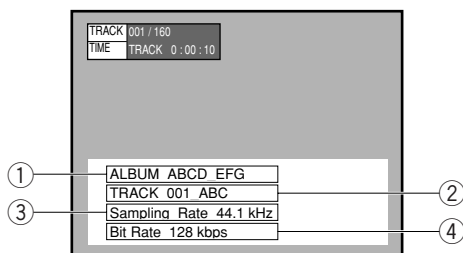

- ① Album (directory) name ③ Sampling frequency
② Track (file) name ④ Bit rate

To stop playback

Press ■.

To pause playback

Press || during playback.

To resume playback, press ► or ||.

Removing the disc

The procedure is the same as that for audio CDs. Refer to "Removing the disc" on page 17.

To fast forward or fast reverse

Press ◀◀/▶▶ during playback.

Each time you press ◀◀/▶▶, the play speed changes as shown below.

▶▶: fast forward



◀◀: fast reverse



If you press ◀◀ during fast forward or ▶▶ during fast reverse, the fast playback direction changes to the opposite with the speed ×2.

The play speed returns to normal at the beginning or end of the track.

There is no audio during fast forward or fast reverse.

To return to normal playback, press ►.

NOTE

The time displayed during fast forward or fast reverse may differ from the actual time on the disc.

To skip to another track during playback

To skip to the next track, press ▶▶.

To return to the beginning of the current or previous track, press ◀◀.

To skip to the desired track directly using the number buttons

The procedure is the same as that for audio CDs. Refer to "Skipping" on page 20.

To check the play time during playback

Press TIME.

The play time is displayed on the TV screen for 10 seconds. Each time the button is pressed, the elapsed time and remaining time of the track being played are displayed alternately on the TV screen and the display window of the DVD player.

On-Screen Display (OSD) menu for the MP3 disc

You can check the general playback status, change the play mode or locate a desired track by displaying and operating the OSD menu.

For details on how to operate the OSD menu, see "Basic operation of the On-Screen Display (OSD) menu" on page 23.

Description of each OSD menu item for the MP3 disc

First (partial) display		
Menu item	Status/setting	Function
TRACK	<ul style="list-style-type: none"> Track number/total number of tracks Total number of tracks in stop mode 	Skip to the desired track.
TIME	Elapsed time or remaining time of track	—



 Press ▲ when the cursor (blue area) is at the top item "TRACK".
 Press ▼ when the cursor is at the bottom item "TIME".

Second (full) display		
Menu item	Status/setting	Function
REPEAT	Repeat play mode	Start repeat playback.
PROGRAM	Program or random play mode	<ul style="list-style-type: none"> Edit program. Start random or programmed playback.

Various MP3 disc operations

Track search

You can specify a desired track to start playback. The procedure is the same as that for audio CDs. Refer to "Title search/track search" on page 26.

Programmed playback

You can select up to 99 tracks from a disc and play them in the programmed order. For the procedure, refer to "PROGRAMMED PLAYBACK" on page 30.

Note, however, that in step 4 when you use the number buttons to select a track, input the track number as follows:

Example: To enter track number 12,
press **0**, **1** and **2**.
To enter track number 156,
press **1**, **5** and **6**.

The directory (album) name and file (track) name are also displayed in the program list menu.

NOTE

The total play time of the program displayed in the program list menu may differ from the actual play time.

Random playback

The procedure is the same as that for audio CDs. Refer to "RANDOM PLAYBACK" on page 29.

Repeat playback

The procedure is the same as that for audio CDs. Refer to "Repeat playback" on page 32 and "Repeating a section between two specified points (A-B repeat)" on page 33.

NOTE

The A-B repeat play function works only when A and B points fall within the same track.

CONNECTING EXTERNAL AUDIO EQUIPMENT

The DIGITAL OUT (OPTICAL) jack and the AUDIO OUT L/R jacks on the DVD player can be used to connect external audio equipment.

Before making connections

- Connect the AC power cords of the system and any external equipment last, after finishing all other connections.
- Refer to the instructions of the connected equipment.

Making a connection with an optical cord

Use an optical cord (not supplied) when connecting the system to audio equipment with an optical digital input jack. Insert the plug of the optical cord into the DIGITAL OUT (OPTICAL) jack of the DVD player as shown below.

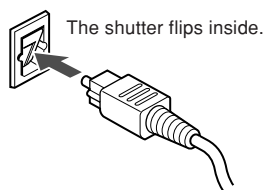

Connecting audio equipment with an optical digital input jack

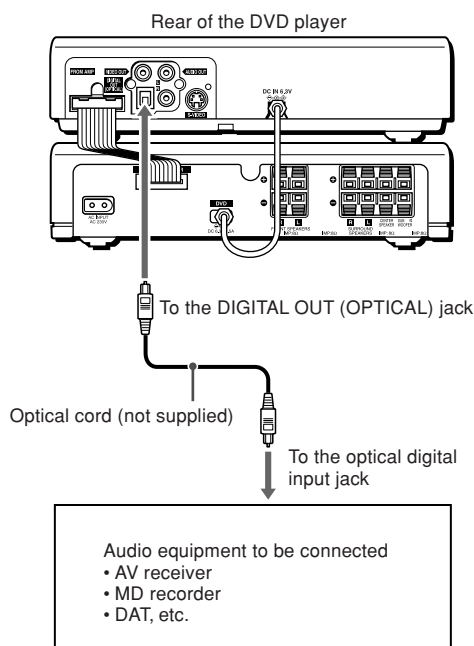

CAUTION

When connecting an AV receiver not equipped with Dolby Digital decoder or DTS decoder using an optical cord, **DO NOT** set "Digital Stream" to "DOLBY DIGITAL" and "dts Output" to "ON" in the "Audio Output Setting" procedure of the setup menu.

Otherwise, merely attempting to play a disc may cause a screeching noise that could be harmful to your ears and damage the speakers.

When connecting to an AV receiver equipped with a digital input connector using an optical cord

Depending on the audio equipment connected to the system, the sound may be dropped or there may be some noise at the beginning of playback or when you have pressed ◀◀/▶▶ or ◀◀/▶▶.

In this case, reconnect the audio equipment to the AUDIO OUT L/R jacks of the DVD player using an audio cord (not supplied).

Connecting audio equipment with analog input jacks

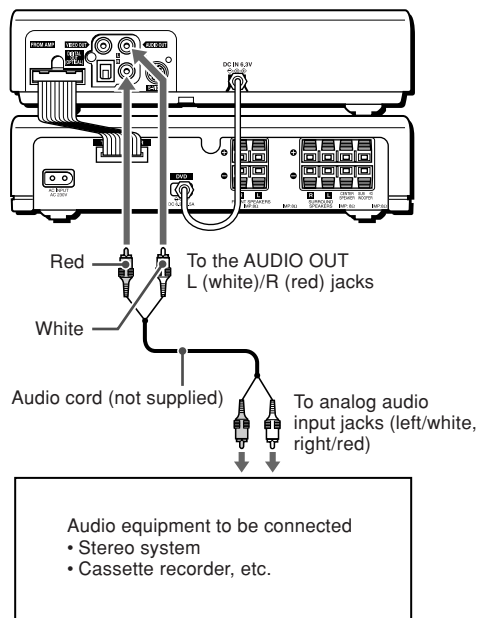

CHANGING SETUP VALUES

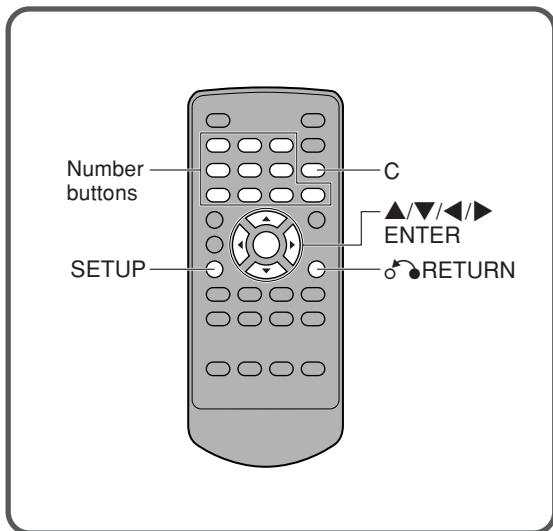

All the basic settings of the system are properly preset at the factory.

- Check that "Audio Output Setting" and "TV Aspect" in the setup menu are correctly set according to the type of equipment connected to the system. For details on the settings, refer to "[2] Connecting to a TV" on page 12 and "CONNECTING EXTERNAL AUDIO EQUIPMENT" on page 40.
- Change any other settings according to your individual setup preferences.

Basic operations in the setup menu

1 Press SETUP in stop mode.

The SETUP MENU screen is displayed on the TV screen.

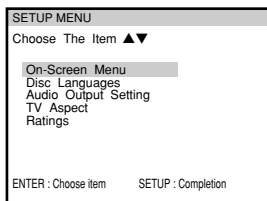

2 Press ▲/▼ repeatedly to select the menu item to be changed, then press ENTER.

On-Screen Menu (page 42)

- Set whether the on-screen guide messages are to be displayed or not.
- Set the on-screen menu language, English, Spanish or French.

Disc Languages (page 43)

Set the audio soundtrack language, subtitle language and the language used in the menu screen.

TV Aspect (page 45)

Set the aspect ratio of the television set connected to the system.

Ratings (page 46)

When playing discs with preset restriction level encoding, this setting allows the system to automatically cut scenes of excessive violence, etc.

Audio Output Setting (page 47)

- Set audio output of the DVD player when an external audio equipment is connected.
- Set individual speakers.

3 Press ▲/▼ repeatedly to select the desired setting, then press ENTER.

The new setting is confirmed.

Note that some menu items require additional steps.

For details of the setting options for each menu item, see the procedure of each setting in the following sections.

4 Press SETUP to exit the setup menu.

To exit the setup menu without making any changes

Press one of the following buttons instead of pressing ENTER in step 3.

RETURN: Returns to the previous menu screen without any changes.

SETUP: Exits the setup menu.

If 10 minutes have elapsed without any operation, the system exits the setup menu automatically.

NOTE

The settings of the setup menu are stored in memory when the system's power is turned off. Therefore, before you unplug the AC power cord from the AC outlet, turn the power off by pressing **POWER** (⏻STANDBY/ON).

CHANGING SETUP VALUES (CONTINUED)

On-Screen Menu

Guide Message:

Set whether the on-screen guide messages at the upper right side of the TV screen are to be displayed or not.

- 1 In the **SETUP MENU**, press **▲/▼** repeatedly to select "On-Screen Menu", then press **ENTER**.

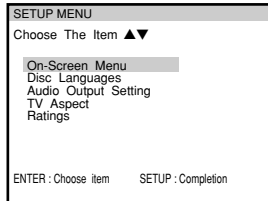

- 2 Press **▲/▼** repeatedly to select "Guide Message".

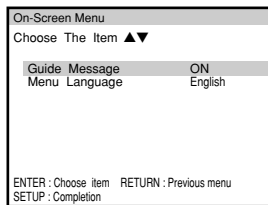

- 3 Press **ENTER** to turn on/off the guide message.

Each time the button is pressed, the setting toggles between "ON" and "OFF".

- 4 Press **○◀** RETURN to return to the previous menu screen or press **SETUP** to exit the setup menu.

Menu Language:

Set the on-screen menu language, English, Spanish or French.

- 1 In the **SETUP MENU**, press **▲/▼** repeatedly to select "On-Screen Menu", then press **ENTER**.

- 2 Press **▲/▼** repeatedly to select "Menu Language", then press **ENTER**.

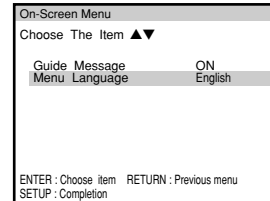

- 3 Press **▲/▼** repeatedly to select the language, then press **ENTER**.

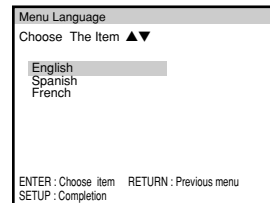

- 4 Press **○◀** RETURN to return to the previous menu screen or press **SETUP** to exit the setup menu.

Disc Languages

NOTE

With some discs, the settings of the "Disc Languages" may be ignored by the system.

Audio Language:

The soundtrack language on a DVD can be changed. If the selected language is not available on the disc, the original language for the disc is selected.

- 1 In the **SETUP MENU**, press **▲/▼** repeatedly to select **"Disc Languages"**, then press **ENTER**.

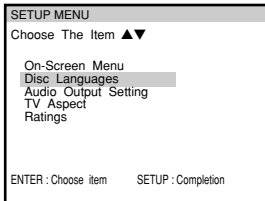

- 2 Press **▲/▼** repeatedly to select **"Audio Language"**, then press **ENTER**.

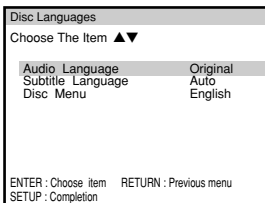

- 3 Press **▲/▼** to select the language, then press **ENTER**.

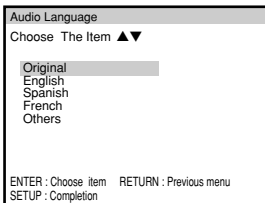

Original: The original language set for the disc is selected. → Go to step **[6]**.

English/Spanish/French: → Go to step **[6]**.

Others: A message prompting you to input a language code appears. → Go to step **[4]**.

- 4 When **"Others"** is selected in step **[3]**, use the number buttons to enter a 4-digit language code referring to the language code list on page 50.

Example: To enter number 4357,
press **4, 3, 5** and then **7**.

If you input a wrong number, press **C** to clear the 4-digit number. Then enter the correct language code again.

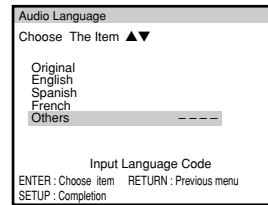

- 5 Press **ENTER**.
Your entry is confirmed.
- 6 Press **○RETURN** to return to the previous menu screen or press **SETUP** to exit the setup menu.

CHANGING SETUP VALUES (CONTINUED)

Subtitle Language:

The subtitle language on a DVD can be changed. If the selected language is not available on the disc, the original language for the disc is selected.

- 1 In the **SETUP MENU**, press **▲/▼** repeatedly to select **"Disc Languages"**, then press **ENTER**.
- 2 Press **▲/▼** repeatedly to select **"Subtitle Language"**, then press **ENTER**.

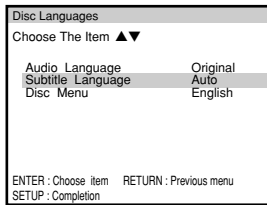

- 3 Press **▲/▼** repeatedly to select the language, then press **ENTER**.

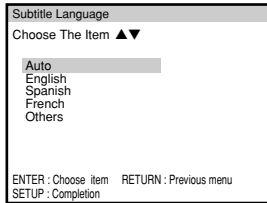

Auto: The subtitle is displayed in the original language selected for the disc.

English/Spanish/French

Others: A message prompting you to input a language code appears. For the procedure of entering a language code, refer to steps [4] and [5] of the "Audio Language" section.

- 4 Press **◀** **RETURN** to return to the previous screen or press **SETUP** to exit the setup menu.

Disc Menu:

The language used in the DVD menu can be changed. If the selected language is not available on the disc, the original language for the disc is selected.

- 1 In the **SETUP MENU**, press **▲/▼** repeatedly to select **"Disc Languages"**, then press **ENTER**.
- 2 Press **▲/▼** repeatedly to select **"Disc Menu"**, then press **ENTER**.

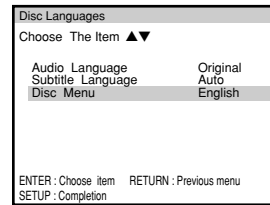

- 3 Press **▲/▼** to select the language, then press **ENTER**.

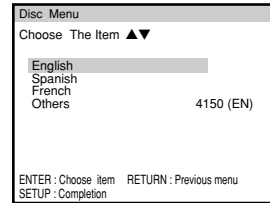

English/Spanish/French

Others: A message prompting you to input a language code appears. For the procedure of entering a language code, refer to steps [4] and [5] of the "Audio Language" section.

- 4 Press **◀** **RETURN** to return to the previous screen or press **SETUP** to exit the setup menu.

TV Aspect

Select the appropriate display format, depending on whether you are using a conventional (4:3) or wide-screen (16:9) TV.

- 1 In the **SETUP MENU**, press **▲/▼** repeatedly to select **"TV Aspect"**, then press **ENTER**.

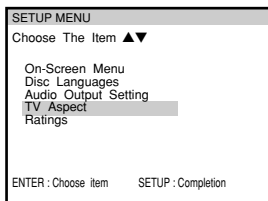

- 2 Press **▲/▼** repeatedly to select the appropriate setting.

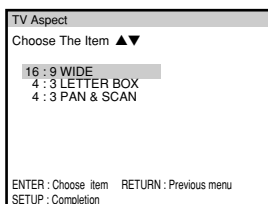

16:9 WIDE

Select this when a wide-screen TV is connected.

Titles recorded in wide-screen (16:9) format will be played at full size. (Setting the wide-screen TV to full-size mode is also necessary.)



16:9 Wide

4:3 LETTER BOX

Select this when a conventional TV is connected. Titles recorded in wide-screen (16:9) format will be played in letterbox mode, with black bands at the top and bottom of the screen.



4:3 Letterbox

4:3 PAN & SCAN

Select this to play titles that include pan-and-scan encoding on a conventional (4:3) TV: the picture of wide-screen titles is displayed at full screen height with the left or right cropped. Other titles will be played in letterbox mode.

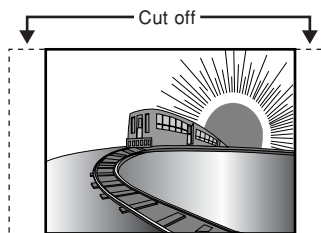

4:3 Pan and scan

- 3 Press **ENTER**.
The display returns to the **SETUP MENU** screen.
- 4 Press **SETUP** to exit the setup menu.

CHANGING SETUP VALUES (CONTINUED)

Ratings

Some DVDs contain a restriction level which enables parents to prevent children from viewing scenes of excessive violence, etc. This system is equipped with a password designed to prevent children from changing the level.

- 1 In the **SETUP MENU**, press **▲/▼** repeatedly to select "Ratings", then press **ENTER**.

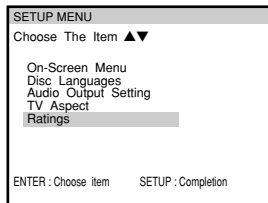

- 2 Press **▲/▼** repeatedly to select the restriction level, then press **ENTER**.

The smaller the number is, the higher the level of restriction becomes. For instance, setting the rating level to 1 will make it impossible to play any disc with a rating level from 2 to 8.

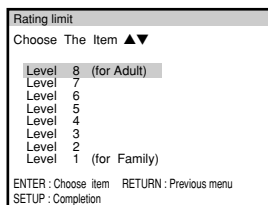

- 3 Press **▲/▼** repeatedly to select the country.

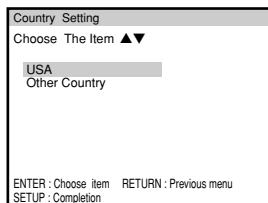

Select "Other Country" if you use the system in an area outside the United States.

- 4 Press **ENTER**.
A password entry screen is displayed.

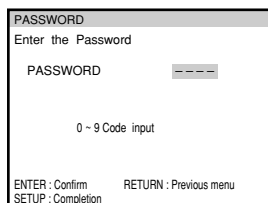

- 5 Enter a 4-digit password using the number buttons.

- 6 Press **ENTER**.

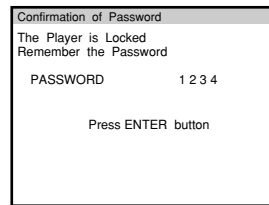

Do not forget the password you set.

- 7 After confirming the password, press **ENTER** again.

The password is saved.

- 8 Press **SETUP** to exit the setup menu.

If you forget the password

Initialize the DVD player of the system and make all settings again including "Ratings" setting. See "How to initialize the DVD player" on page 51.

To change the settings

- 1 In the **SETUP MENU**, press **▲/▼** repeatedly to select "Ratings", then press **ENTER**.

- 2 Input the password and press **ENTER**.

- 3 Press **▲/▼** repeatedly to select the item you want to change, then press **ENTER**.

Unlock Player: Select this to cancel the restriction.

Change Password: Select this to cancel the password and enter a new one.

Change Level: Select this to change the level of the restriction.

Setting of the Country: Select this to change the country setting.

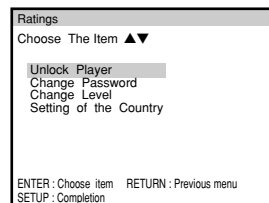

- 4 Follow the instruction displayed on the subsequent menu screen.

- 5 Press **SETUP** to exit the setup menu.

Audio Output Setting

Set the audio output of the system according to the type of other external audio equipment connected to the system.

- When connecting other external audio equipment to the AUDIO OUT L/R jacks of the DVD player, you need to set "**Downmix Type**" only.
- When connecting an external AV receiver not equipped with Dolby Digital decoder or DTS decoder to the DIGITAL OUT (OPTICAL) jack of the DVD player, you need not make any settings.
- When playing DVDs with Dolby Digital or DTS Digital Surround sound on an external AV receiver equipped with Dolby Digital decoder and/or DTS decoder, set "**Digital Stream**" or "**dts Output**" as follows:
 - When playing DVDs with Dolby Digital sound
Digital Stream: DOLBY DIGITAL
 - When playing DVDs with DTS Digital Surround sound
dts Output: ON

CAUTION

When connecting an external AV receiver not equipped with Dolby Digital decoder or DTS decoder using an optical cord, **DO NOT** set "**Digital Stream**" to "**DOLBY DIGITAL**" or "**dts Output**" to "**ON**". Otherwise, merely attempting to play a disc may cause a screeching noise that could be harmful to your ears and damage the speakers.

Digital Stream:

Select the digital audio signal to be output from the DIGITAL OUT (OPTICAL) jack of the DVD player.

- 1 In the **SETUP MENU**, press **▲/▼** repeatedly to select "**Audio Output Setting**", then press **ENTER**.

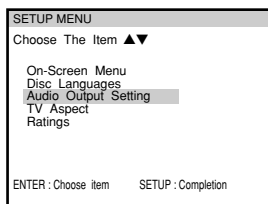

- 2 Press **▲/▼** repeatedly to select "**Digital Stream**".

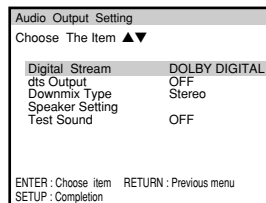

- 3 Press **ENTER** to select the appropriate setting. Each time the button is pressed, the setting toggles between "**Downmix PCM**" and "**DOLBY DIGITAL**".

Downmix PCM

Select this option if the system is connected to an external AV receiver which is not equipped with a Dolby Digital decoder.

DOLBY DIGITAL

Select this option if the system is connected to an external AV receiver which is equipped with a Dolby Digital decoder.

- 4 Press **○/◀** RETURN to return to the previous menu screen or press **SETUP** to exit the setup menu.

dts Output:

Set the dts output according to whether the connected external AV receiver is equipped with a DTS decoder or not.

- 1 In the **SETUP MENU**, press **▲/▼** repeatedly to select "**Audio Output Setting**", then press **ENTER**.
- 2 Press **▲/▼** repeatedly to select "**dts Output**".

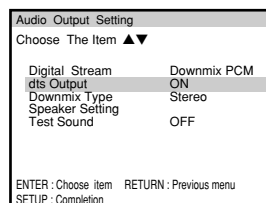

CHANGING SETUP VALUES (CONTINUED)

- 3 Press **ENTER** to select the appropriate setting.
Each time the button is pressed, the setting toggles between "ON" and "OFF".

ON

Select this option if the system is connected to an external AV receiver which is equipped with a DTS decoder.

OFF

Select this option if the system is connected to an external AV receiver which is not equipped with a DTS decoder.

- 4 Press **RETURN** to return to the previous screen or press **SETUP** to exit the setup menu.

Downmix Type:

Set the analog output to be output from the AUDIO OUT L/R jacks of the DVD player.

- 1 In the **SETUP MENU**, press **▲/▼** repeatedly to select "Audio Output Setting", then press **ENTER**.

- 2 Press **▲/▼** repeatedly to select "Downmix Type".

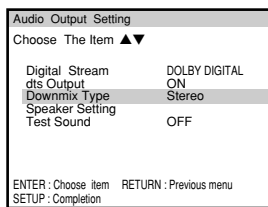

- 3 Press **ENTER** to select the appropriate setting.
Each time the button is pressed, the setting toggles between "Stereo" and "Surround".

Stereo

Select this option if the system is connected to a conventional audio stereo system.

Surround

Select this option if the system is connected to a Dolby Pro Logic Surround system.

- 4 Press **RETURN** to return to the previous menu screen or press **SETUP** to exit the setup menu.

Speaker Setting:

Set the distance from the listening position to each speaker. Based on the distance setting, the system calculates the delay times of the respective speakers so that the sounds from them are centered at the listening position.

- 1 In the **SETUP MENU**, press **▲/▼** repeatedly to select "Audio Output Setting", then press **ENTER**.

- 2 Press **▲/▼** repeatedly to select "Speaker Setting".

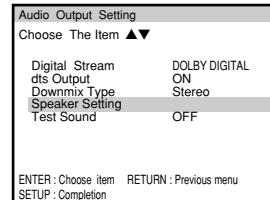

- 3 Press **ENTER**.

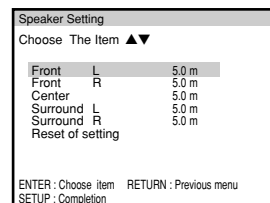

- 4 Press **▲/▼** repeatedly to select the speaker to set the distance, then press **ENTER**.

Example: When selecting "FRONT L"

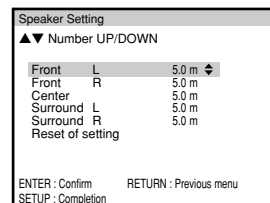

If you select "Reset of setting" and press **ENTER**, the distance settings for all speakers are reset to "5.0 m".

- 5 Press **▲/▼** repeatedly to set the distance between the listening position and the speaker you selected in step 4.

The distance can be set from 0.6 m to 10.0 m in units of 0.2 m.

- 6 Press **ENTER**.
- 7 Repeat steps 4 to 6 to set the distances for other speakers.
- 8 Press **RETURN** to return to the previous menu screen or press **SETUP** to exit the setup menu.

Test Sound:

A test tone is generated from each speaker allowing you to check that the sounds from the respective speakers are centered at the listening position. Use this function after performing the "Speaker Setting" procedure.

- 1 In the **SETUP MENU**, press **▲/▼** repeatedly to select "Audio Output Setting", then press **ENTER**.

- 2 Press **▲/▼** repeatedly to select "Test Sound".

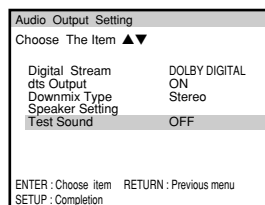

- 3 Press **ENTER** to turn on or off the speaker test. Each time the button is pressed, the selection toggles between "ON" and "OFF".

ON

The test tone is generated from each speaker in the following order:

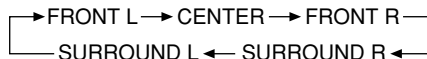

Check that the test tone from each speaker sounds the same in volume at the listening position.

OFF

The system stops generating the test tone.

The system also stops generating the test tone when:

- you press **▲/▼** to move to another menu item.
- you press **SETUP** to exit the setup menu.
- you open or close the disc cover.
- 10 minutes have elapsed without any operation.
- you turn off the power.

CHANGING SETUP VALUES (CONTINUED)

Language codes

Code	Language	Code	Language	Code	Language
3737	Afar	4457	Hungarian	5256	Portuguese
3738	Abkhazian	4461	Armenian	5357	Quechua
3742	Afrikaans	4537	Interlingua	5449	Rhaeto-Romance
3749	Amharic	4550	Indonesian	5451	Romanian
3754	Arabic	4555	Icelandic	5457	Russian
3755	Assamese	4556	Italian	5537	Sanskrit
3760	Aymara	4559	Hebrew	5540	Sindhi
3762	Azerbaijani	4637	Japanese	5544	Serbo-Croatian
3837	Bashkir	4645	Yiddish	5545	Singhalese
3841	Byelorussian	4659	Javanese	5547	Slovak
3843	Bulgarian	4737	Georgian	5548	Slovenian
3844	Bihari	4747	Kazakh	5549	Samoaan
3850	Bengali; Bangla	4748	Greenlandic	5550	Shona
3851	Tibetan	4749	Cambodian	5551	Somali
3854	Breton	4750	Kannada	5553	Albanian
3937	Catalan	4751	Korean	5554	Serbian
3951	Corsican	4755	Kashmiri	5557	Sundanese
3955	Czech	4757	Kurdish	5558	Swedish
3961	Welsh	4761	Kirghiz	5559	Swahili
4037	Danish	4837	Latin	5637	Tamil
4041	German	4850	Lingala	5641	Telugu
4062	Bhutani	4851	Laothian	5643	Tajik
4148	Greek	4856	Lithuanian	5644	Thai
4150	English	4858	Latvian; Lettish	5645	Tigrinya
4151	Esperanto	4943	Malagasy	5647	Turkmen
4155	Spanish	4945	Maori	5648	Tagalog
4156	Estonian	4947	Macedonian	5651	Tonga
4157	Basque	4948	Malayalam	5654	Turkish
4237	Persian	4950	Mongolian	5656	Tatar
4845	Finnish	4951	Moldavian	5659	Twí
4246	Fiji	4954	Marathi	5747	Ukrainian
4251	Faroese	4955	Malay	5747	Urdu
4254	French	4956	Maltese	5762	Uzbek
4261	Frisian	4961	Burmese	5845	Vietnamese
4337	Irish	5037	Nauru	5851	Volapük
4340	Scots Gaelic	5041	Nepali	5951	Wolof
4348	Galician	5048	Dutch	6044	Xhosa
4350	Guarani	5051	Norwegian	6151	Yoruba
4357	Gujarati	5154	Oriya	6244	Chinese
4437	Hausa	5237	Punjabi	6257	Zulu
4445	Hindi	5237	Polish		
4454	Croatian	5255	Pashto; Pushto		

TROUBLESHOOTING

If something seems to be wrong with the system, first check the items in the table below.

Symptom	Check	See page
The power does not come on.	<ul style="list-style-type: none"> Is the AC power cord plugged firmly into a live outlet? Is the DC cord connected properly? 	11, 15 11, 12
The disc does not play. Playback stops almost immediately.	<ul style="list-style-type: none"> Is there condensation inside the system? (Leave the system idle with the power on for 1 to 2 hours.) Are you trying to use a disc that can't be played, such as a PHOTO CD? Is the disc dirty? Is it loaded properly? Does the disc exceed the specified rating level? 	2 4 6, 16 46
No picture	<ul style="list-style-type: none"> Is the system connected correctly? Are the video connections firmly attached? Is the television video mode set correctly? 	11, 12, 13 11, 12, 13 16
The picture quality is poor.	<ul style="list-style-type: none"> Is the system in a place subject to vibrations? Are the video connections firmly attached? Is the disc dirty? Is the system connected directly to the television set? Or is it connected through a video deck, a selector switch, or a television with a built-in video deck? <p>The picture may be bad when used with some television sets or projectors, due to the DVD copy protection scheme.</p> <p>The picture quality may also suffer if the system is connected through a selector switch with other video equipment. Try turning off the power to the other video equipment.</p> <p>The picture quality may be somewhat poor when paused, when doing frame advance, or during fast forward or fast reverse. This is not a malfunction.</p>	2 11, 12, 13 6 11
No sound	<ul style="list-style-type: none"> Is the system connected correctly? Are the speaker cords inserted firmly into the speaker terminals? Has a short circuit occurred at the speaker terminals? Is the connected audio equipment turned on? Is the volume of the connected equipment set correctly? (Note that there is no audio during slow playback, frame advance and fast forward/reverse except with audio CDs.) 	11, 14 11, 14 16, 17
The remote control does not work, or does not work correctly.	<ul style="list-style-type: none"> Is the remote control battery installed correctly? Is the remote control too far from the system? Is there something in the way? Is the remote control battery getting weak? Is the system in sunlight or strong fluorescent light? 	7 7 7 7
No response from the system	<ul style="list-style-type: none"> Hold down TIME on the DVD player for more than 4 seconds. After the power is turned off, press POWER (⏻STANDBY/ON) again to restore the system. 	—

Each DVD has different capabilities

The DVD's many capabilities differ depending on the disc. The following situations may be caused by information on the disc itself.

- The audio or subtitles are not reproduced in the language specified in the setup menu.
- The audio track or subtitles cannot be changed.
- There are no subtitles.
- No DVD menu. The DVD menu is not displayed in the language you want.
- The view angle cannot be changed.
- The rating restriction does not work.
- The resume or mark function does not work.

How to initialize the DVD player

Turn off the power and open the disc cover. Then, while holding down **■**, press **POWER ⏻STANDBY/ON**. The initial condition is restored and "CLEAR" appears on the display window.

As all the settings after purchase return to the initial condition, set them again.

SPECIFICATIONS

DVD player XD-DV1

Power supply	6.3 V DC, 1.5 A
Weight	770 g (1 lb 11 oz)
External dimensions	230 × 62.5 × 189 mm (9 1/8 × 2 1/2 × 7 1/2 in.) (w × h × d)
Laser	Semiconductor laser, wavelength: 650/780 nm
Signal format	NTSC
Supported discs	DVD video discs: 12-cm discs (single-sided single layer, single-sided double layer, double-sided double layer), 8-cm discs (single-sided single layer, single-sided double layer, double- sided double layer) Compact discs (CD-DA, video CD, MP3 discs): 12-cm and 8-cm discs
Video composite output	1.0 Vp-p (75 ohms, sync negative) RCA jack × 1
S-video output	Y output: 1.0 Vp-p (75 ohms, sync negative) C output: 0.286 Vp-p (75 ohms) 4-pin Mini DIN jack × 1
Audio output	Analog output: 130 mV RMS (1 kHz, -20 dB) RCA jack (L/R) × 1 Digital output: Fibre optic connector × 1
Audio output characteristics	Frequency range: CD/VCD: 20 Hz to 20 kHz DVD: 20 Hz to 22 kHz (48-kHz/96-kHz sampling)

Amplifier XA-DV1

Maximum effective output power	FRONT L/R: 30 W + 30 W (1 kHz, 8 ohms, 10%) EIAJ SURROUND L/R: 30 W + 30 W (1 kHz, 8 ohms, 10%) EIAJ CENTER: 30 W (1 kHz, 8 ohms, 10%) EIAJ SUB WOOFER: 30 W (100 Hz, 8 ohms, 10%) EIAJ
Output terminals	FRONT SPEAKERS: 8 ohms SURROUND SPEAKERS: 8 ohms CENTER SPEAKER: 8 ohms SUB WOOFER: 8 ohms PHONES: 32 ohms
Power supply	120 V AC, 60 Hz
Power consumption	50 W (operation mode) 3.2 W (standby mode)
Weight	1.4 kg (3 lbs 1 oz)
External dimensions	230 × 62.5 × 210.6 mm (9 1/8 × 2 1/2 × 8 3/8 in.) (w × h × d)

Speaker system SX-DV1

Speaker type	Front/surround/center: 8-cm (3 1/4 in.) full range cone type Subwoofer: 13 cm (5 1/8 in.), bass reflex type
External dimensions	Front/surround/center: 96 × 96.5 × 96.5 mm (3 28/32 × 3 29/32 × 3 29/32 in.) (w × h × d) Subwoofer: 160 × 205 × 235 mm (6 3/8 × 8 1/8 × 9 3/8 in.) (w × h × d)
Weight	Front/surround/center: 0.52 kg (1 lb 2 oz) Subwoofer: 3.0 kg (6 lbs 10 oz)

General

Operating temperatures	5°C to 35°C (41°F to 95°F)
Accessories	Video cord (1) Remote control (1) AC power cord (1) DC cord (1) Speaker cords (6) Battery (installed in the remote control) (1) Operating instructions

Specifications are subject to change without notice.

NOTE

This equipment has been tested and found to comply with the limits for a Class B digital device, pursuant to Part 15 of the FCC Rules. These limits are designed to provide reasonable protection against harmful interference in a residential installation.

This equipment generates, uses, and can radiate radio frequency energy and, if not installed and used in accordance with the instructions, may cause harmful interference to radio communications. However, there is no guarantee that interference will not occur in a particular installation. If this equipment does cause harmful interference to radio or television reception, which can be determined by turning the equipment off and on, the user is encouraged to try to correct the interference by one or more of the following measures:

- Reorient or relocate the receiving antenna.
- Increase the separation between the equipment and receiver.
- Connect the equipment into an outlet on circuit different from that to which the receiver is connected.
- Consult the dealer or an experienced radio/TV technician for help.

CAUTION

Modifications or adjustments to this product, which are not expressly approved by the manufacturer, may void the user's right or authority to operate this product.

- Manufactured under license from Dolby Laboratories. "Dolby", "Pro Logic" and the double-D symbol are trademarks of Dolby Laboratories. Confidential unpublished works. ©1992-1997 Dolby Laboratories. All rights reserved.
- Manufactured under license from Digital Theater Systems, Inc. US Pat. No. 5,451,942 and other worldwide patents issued and pending. "DTS" and "DTS Digital Surround" are trademarks of Digital Theater Systems, Inc. ©1996 Digital Theater Systems, Inc. All rights reserved.

AIWA CO.,LTD.

 <http://www.aiwa.co.jp>

For Assistance and Information, **Call Toll Free 1-800-BUY-AIWA** (United States and Puerto Rico)

Printed in Malaysia

CORRECTIONS

Please read the incorrect descriptions in the Operating Instructions as follows.

Note:

The page numbers in parentheses are different between the two versions of the Operating Instructions.

U: page number of the U version for the customers in the United States

K: page number of the K version for the customers in the United Kingdom

CAUTION

(U: page 7)

CAUTION

- **Lithium battery (CR2025) for the remote control**
Replace the battery with Hitachi Maxell, Panasonic, or Sony, Part No. CR2025 only. Use of another battery may present a risk of fire or explosion.

The battery may explode if mistreated. Do not recharge, disassemble or dispose of in fire.

- Do not keep metallic objects such as rings, bracelets, and keys near the battery. They may cause the battery to short circuit.
- After removing the battery, be sure to keep it out of reach of children. If it is swallowed, consult a doctor immediately.

CAUTION

(U: page 40, K: page 42)

When connecting an AV receiver not equipped with Dolby Digital decoder using an optical cord, **DO NOT** set "Digital Stream" to "DOLBY DIGITAL" in the "Audio Output Setting" procedure of the setup menu.

Otherwise, merely attempting to play a disc may cause a screeching noise that could be harmful to your ears and damage the speakers.

Audio Output Setting

(U: page 47, K: page 49)

Set the audio output of the system according to the type of other external audio equipment connected to the system.

NOTE

The system outputs only PCM digital signals converted from DTS bit-stream signals when playing DTS-encoded discs.

- When connecting other external audio equipment to the AUDIO OUT L/R jacks of the DVD player, you need to set "**Downmix Type**" only.
- When connecting an external AV receiver not equipped with Dolby Digital decoder to the DIGITAL OUT (OPTICAL) jack of the DVD player, you need not make any settings.
- When playing DVDs with Dolby Digital sound on an external AV receiver equipped with Dolby Digital decoder, set "**Digital Stream**" to "DOLBY DIGITAL".

CAUTION

(U: page 47, K: page 49)

The same correction as for page 40 (U) or page 42 (K) above.

dts Output:

(U: pages 47 and 48, K: pages 49 and 50)

Set whether PCM digital signals converted from DTS bit-stream signals are output from the DIGITAL OUT (OPTICAL) jack or not.

NOTE

The system cannot output DTS bit-stream signals directly from the DIGITAL OUT (OPTICAL) jack when playing DTS-encoded discs.

- 1 **In the SETUP MENU, press ▲/▼ repeatedly to select "Audio Output Setting", then press ENTER.**
- 2 **Press ▲/▼ repeatedly to select "dts Output".**
- 3 **Press ENTER to select the appropriate setting.**
Each time the button is pressed, the setting toggles between "ON" and "OFF".
ON
PCM digital signals converted from DTS bit-stream signals are output from the DIGITAL OUT (OPTICAL) jack.
OFF
PCM digital signals converted from DTS bit-stream signals are not output from the DIGITAL OUT (OPTICAL) jack.
- 4 **Press ⏪ RETURN to return to the previous screen or press SETUP to exit the setup menu.**

Speaker Setting:

(U: page 48, K: page 50)

Set the audio balance among the speakers from the listening position.

Based on the distance setting from the listening position, the system calculates and adjusts the delay times of the respective speakers so that the sounds from them are centered at the listening position.

Test Sound:

(U: page 49, K: page 51)

A test tone is generated from each speaker allowing you to check the audio balance among the speakers from the listening position. If the volume levels of the speakers are noticeably different from each other at the listening position, adjust the position or direction of the speakers.

CORRECCIONES

Lea las descripciones incorrectas del manual de instrucciones de la forma siguiente.

PRECAUCIÓN (página 7)

PRECAUCIONES

- **Pila de litio (CR2025) apara el mando a distancia**
Sustituya las pilas por unas de Hitachi Maxell, Panasonic o Sony, únicamente parte nº CR2025. El uso de otras pilas puede presentar un riesgo de incendio o explosión.
Las pilas pueden explotar si no se tratan con cuidado. No las recargue, desmonte o tire al fuego.
- No coloque objetos metálicos, como anillos, pulseras, o llaves cerca de la pila. Estos objetos podrían cortocircuitar la pila.
- Después de haber extraído la pila, cerciórese de guardarla fuera del alcance de niños. Si alguien tragase la pila, póngase inmediatamente en contacto con un médico.

PRECAUCIÓN (página 40)

Cuando conecte un receptor AV que no esté equipado con descodificador Dolby Digital empleando un cable óptico, **NO AJUSTE "Digital Stream" en "DOLBY DIGITAL"** en el procedimiento de "Configuración salida audio" del menú de configuración.

De lo contrario, al intentar simplemente la reproducción de un disco podría producirse un ruido estridente capaz de herirle los oídos y de causar daños en los altavoces.

Configuración salida audio (página 47)

Ajuste la salida de audio del sistema de acuerdo con el tipo del otro equipo de audio externo que haya conectado al sistema.

NOTA

Cuando el sistema reproduce discos con codificación DTS, emite sólo las señales de secuencia de bits DTS convertidas a señales PCM digitales.

- Cuando conecte otro equipo de audio externo a las tomas AUDIO OUT L/R del reproductor DVD, sólo necesitara ajustar el "Tipo de mezcla".
- Cuando conecte un receptor AV externo, que no esté equipado con descodificador Dolby Digital, a la toma DIGITAL OUT (OPTICAL) del reproductor DVD, no será necesario que realice ningún ajuste.
- Cuando reproduzca discos DVD con sonido Dolby Digital en un receptor AV externo equipado con descodificador Dolby Digital, ajuste "Digital Stream" en "DOLBY DIGITAL".

PRECAUCIÓN (página 47)

La misma corrección que la de la página 40 anterior.

Salida dts: (páginas 47 y 48)

Seleccione si las señales PCM digitales, convertidas desde las señales de secuencia de bits DTS, deben, o no deben, emitirse por la toma DIGITAL OUT (OPTICAL).

NOTA

El sistema no puede emitir las señales de secuencia de bits DTS directamente por la toma DIGITAL OUT (OPTICAL) cuando se reproducen discos con codificación DTS.

- 1 **En el MENÚ DE CONFIGURACIÓN, presione repetidamente ▲/▼ para seleccionar "Configuración salida audio", y después presione ENTER.**
- 2 **Presione repetidamente ▲/▼ para seleccionar "Salida dts".**
- 3 **Presione ENTER para seleccionar el ajuste apropiado.**
Cada vez que presione el botón, el ajuste cambiará entre "ACTIVAR" y "DESACTIVAR".

ACTIVAR

Las señales PCM digitales, convertidas desde las señales de secuencia de bits DTS, se emiten por la toma DIGITAL OUT (OPTICAL).

DESACTIVAR

Las señales PCM digitales, convertidas desde las señales de secuencia de bits DTS, no se emiten por la toma DIGITAL OUT (OPTICAL).

- 4 **Para volver a la pantalla del menú anterior, presione ⏪RETURN, y para salir del menú de configuración, presione SETUP.**

Ajuste de los altavoces: (página 48)

Ajuste el balance del sonido entre los altavoces desde la posición de audición.

El sistema calcula y ajusta los tiempos de retardo de los altavoces respectivos, basándose en el ajuste de la distancia desde la posición de audición, de modo que el sonido que emite cada altavoz se centre en la posición de audición.

Sonido de prueba: (página 49)

Se genera un tono de prueba desde cada altavoz para permitirle comprobar el balance del sonido entre los altavoces desde la posición de audición. Si los niveles de volumen de los altavoces son apreciablemente distintos entre sí en la posición de audición, ajuste la posición o la dirección de los altavoces.

Attach the anti-skid pads to the subwoofer

Attach the supplied anti-skid pads to the bottom of the subwoofer to stabilize the subwoofer and prevent it from slipping.

Fijación de los amortiguadores antideslizables al altavoz de subgraves

Fije los amortiguadores antideslizables a la base del altavoz de subgraves para estabilizarlo y evitar que se deslice.

Fixation des pastilles antidérapantes sous le caisson de grave

Fixez les pastilles antidérapantes fournies sous le caisson de grave pour le stabiliser et l'empêcher de glisser.

Bringen Sie die Gleitschutzpolster am Tieftöner an

Bringen Sie die mitgelieferten Gleitschutzpolster an der Unterseite des Tieftöners an, damit er stabil steht und nicht verrutschen kann.

Applicare i cuscinetti antiscivolo al subwoofer

Applicare i cuscinetti antiscivolo in dotazione al fondo del subwoofer per stabilizzare il subwoofer e evitare che scivoli.

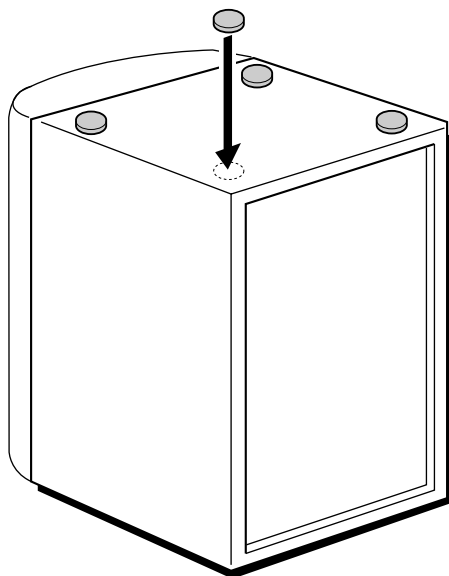

Anti-slip voetjes onder de lagetonen-luidspreker aanbrengen

Bevestig de bijgeleverde anti-slip voetjes aan de onderkant van de lagetonen-luidspreker, om te zorgen dat die stevig staat en niet kan wegglijden.

Připevněte protiskluzové podložky na basový reproduktor

Připevněte dodané protiskluzové podložky na spodní stranu basového reproduktoru, tím stabilizujete basový reproduktor a zabráníte jeho sklouznutí.

A csúszásgátló korongok subwoofer-re helyezése

Helyezze a csúszásgátló korongokat a subwoofer aljára, hogy azok stabilizálják a subwoofer-t, és megakadályozzák annak elcsúszását.

Przymocuj do subwoofera osłony antypoślizgowe.

Przymocuj dostarczone z wyposażenia osłony antypoślizgowe do spodniej części subwoofera w celu jego stabilizacji i uniknięcia przesuwania.

