

MINOLTA

The essentials of imaging

www.minolta.com

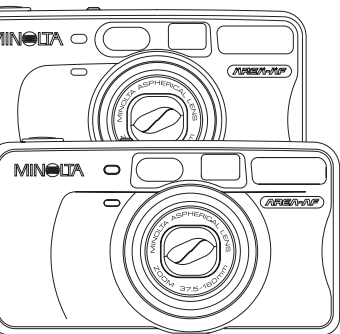

FREEDOM ZOOM 140/160

RIVA ZOOM 140/160

E INSTRUCTION MANUAL

CONTENTS

Thank you for your purchasing this Minolta camera. Before using your new camera, please take the time to read through this instruction manual for it contains important information on the use and care of your camera.

This is the combined manual for the Freedom/Riva Zoom 140/160 models. The description pertaining to each model is referred to as the “**140 model**” or “**160 model.**”

For Proper and Safe Use 4

GETTING STARTED

Names of Parts 10
Attaching the Camera Strap 16
Inserting the Battery 17
Battery-condition Indicator 18
Loading the Film 19

BASIC OPERATION

Fully Automatic Operation 22
Area-AF Focus-area Indicator 27
Focus Lock - Area AF 28
Focusing Range 29
Special Focusing Situations 30
For Closer Subjects 32
Rewinding the Film 34

ADVANCED OPERATION

Selecting the AF Mode	36
Area AF	37
Focus-area Indicator Controls	38
Spot AF.....	40
Focus Lock - Spot AF.....	41
Target AF	42
Selecting the Flash Mode	44
Flash Range	46
Autoflash	47
Autoflash with Red-eye Reduction	48
Fill-flash	49
Flash cancel	50
Night Portrait	51
Exposure Compensation	52

Self-timer	53
Continuous Advance.....	55
For Owners of the Quartz-date model..	
.....	57
Date and Time Imprinting	57
Remote Control Operation	63
Viewfinder Brightness	70

APPENDIX

Care and Storage	73
Technical Specifications	78

FOR PROPER AND SAFE USE

Read and understand all warnings and cautions before using this product.

WARNING

Using batteries improperly can cause them to leak harmful solutions, overheat, or explode which may damage property or cause personal injury. Do not ignore the following warnings:

- Only use the batteries specified in this instruction manual.
- Do not install the batteries with the polarity (+/-) reversed.
- Do not use batteries which show wear or damage.
- Do not expose batteries to fire, high temperatures, water, or moisture.
- Do not attempt to recharge, short, or disassemble batteries.
- Do not store batteries near or in metallic products.
- Do not use leaking batteries. If fluid from the batteries enters your eye, immediately rinse the eye with plenty of fresh water and contact a doctor. If fluid from the batteries makes contact with your skin or clothing, wash the area thoroughly with water.

- Tape over lithium battery contacts to avoid short-circuiting during disposal; always follow local regulations for battery disposal.
- Do not disassemble this product. Electric shock may cause injury if a high voltage circuit inside the product is touched. Take the product to a Minolta Service Facility when repairs are required.
- Immediately remove the batteries and discontinue use if the camera is dropped or subjected to an impact in which the interior, especially the flash unit, is exposed. The flash has a high voltage circuit which may cause an electric shock resulting in injury. The continued use of a damaged product or part may cause injuries.
- Keep batteries or small parts that could be swallowed away from infants. Contact a doctor immediately if an object is swallowed.
- Store this product out of reach of children. Be careful when around children, not to harm them with the product or parts.

FOR PROPER AND SAFE USE

- Do not fire the flash directly into the eyes. It may damage eyesight.
- Do not fire the flash at vehicle operators. It may cause a distraction or temporary blindness which may lead to an accident.
- Do not look directly at the sun or strong light sources through the viewfinder. It may damage your eyesight or cause blindness.
- Do not expose this product to liquids or operate this product with wet hands. If liquid enters the product, immediately remove the batteries and discontinue use. The continued use of a product exposed to liquids may cause damage or injury through fire or electric shock.
- Do not use the product near inflammable gases or liquids such as gasoline, benzene, or paint thinner. Do not use inflammable products such as alcohol, benzene, or paint thinner to clean the product. The use of inflammable cleaners and solvents may cause an explosion or fire.
- If the product emits a strange odor, heat, or smoke, discontinue use. Immediately remove the batteries taking care not to burn yourself. The continued use of a damaged product or part may cause injuries.

- Take the product to a Minolta Service Facility when repairs are required.

CAUTION

- Do not use or store the product in a hot or humid environment such as the glove compartment or trunk of a car. It may damage the product and batteries which may result in burns or injuries caused by heat, fire, explosion, or leaking battery fluid.
- If batteries are leaking, discontinue use of the product.
- The lens retracts when the camera is turned off or the auto-power-off function is activated. Touching the lens barrel while it is retracting may cause injury.
- Do not fire the flash while it is in contact with people or objects. The flash unit discharges a large amount of energy which may cause burns.

FOR PROPER AND SAFE USE

This device complies with Part 15 of the FCC Rules. Operation is subject to the following two conditions: (1) This device may not cause harmful interference, and (2) this device must accept any interference received, including interference that may cause undesired operation. Changes or modifications not approved by the party responsible for compliance could void the user's authority to operate the equipment. This equipment has been tested and found to comply with the limits for a Class B digital device, pursuant to Part 15 of the FCC Rules. These limits are designed to provide reasonable protection against harmful interference in a residential installation. This equipment generates, uses and can radiate radio frequency energy and, if not installed and used in accordance with the instructions, may cause harmful interference to radio communications. However, there is no guarantee that interference will not occur in a particular installation.

If this equipment does cause harmful interference to radio or television reception, which can be determined by turning the equipment off and on, the user is encouraged to try to correct the interference by one or more of the following measures:

- Reorient or relocate the receiving antenna.
- Increase the separation between the equipment and the receiver.
- Connect the equipment to an outlet on a circuit different from that to which the receiver is connected.
- Consult the dealer or an experienced radio/TV technician for help.

This Class B digital apparatus complies with Canadian ICES-003.



This mark on your camera certifies that this camera meets the requirements of the EU (European Union) concerning interference causing equipment regulations. CE stands for Conformité Européenne (European Conformity).

NAMES OF PARTS

BODY The **160 quartz-date model** is illustrated.

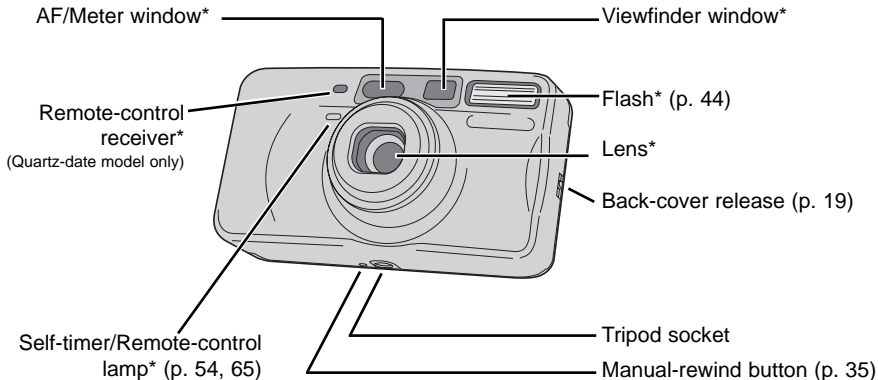

* This camera is a sophisticated optical instrument. Care should be taken to keep these surfaces clean. Refer to the care and storage section at the back of this manual (p. 73).

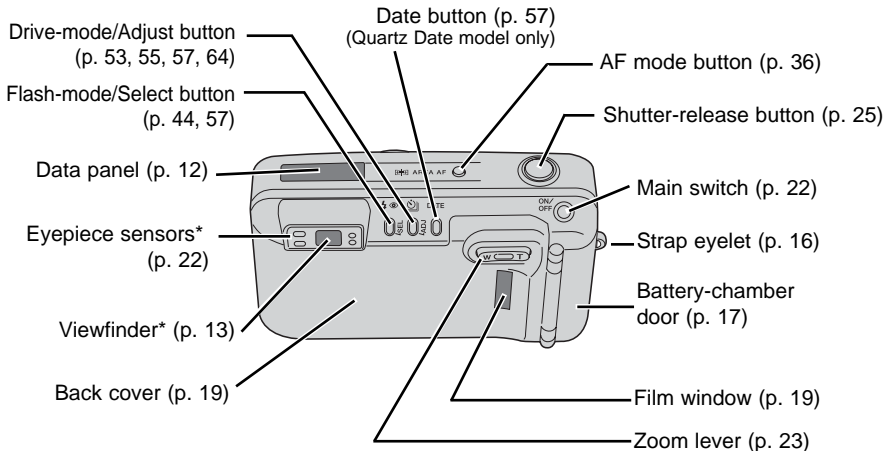

Continued on next page.

NAMES OF PARTS

DATA PANEL

All indicators are displayed for clarity.

Date/Time display (p. 57)
(Quartz-Date model only)

Remote-control indicator (p. 64) (Quartz-date model only)

Battery-condition indicator (p. 18)

Frame counter (p. 21)

Film-transport signals (p. 21)

Cartridge mark (p. 34)





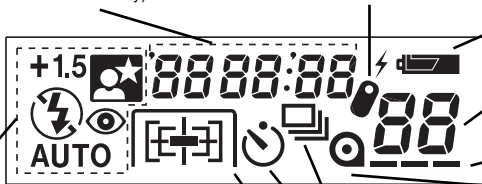

Continuous-advance indicator (p. 55) (160 model)



Self-timer indicator (p. 53)

AF mode indicators (p. 36)



Flash-mode indicators (p. 44)

-  Autoflash
-  Autoflash with red-eye reduction
-  Fill-flash
-  Flash cancel
-  Night Portrait (with red-eye reduction)
-  Exposure Compensation (160 model only)

-  Area AF
-  Spot AF
-  Target AF

VIEWFINDER

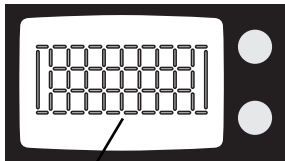

All focus frames and focus-area indicators are shown. This camera features a sophisticated matrix AF indication system that indicates the area of focus.

Focus-frame Display

Area AF (p. 37)

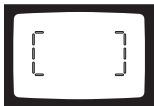

Spot AF (p. 40)



Target AF (p. 42)



For focus-area indicators in Area AF, see pages 24 and 27.

Continued on next page.

NAMES OF PARTS

VIEWFINDER

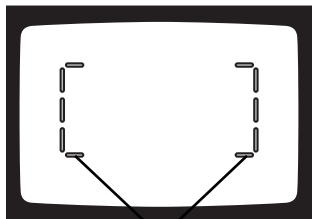

Focus frames
(Area AF)

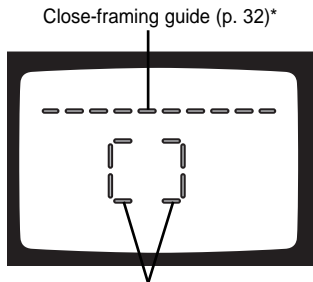

Close-framing guide (p. 32)*
Focus-area indicator (p. 27)**
Varies according to the subject.

* The close-framing guide appears in Area, spot, and target-AF modes.

** The focus-area indicator is displayed in the Area-AF mode.

VIEWFINDER

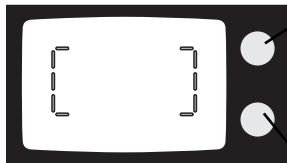
**Focus lamp (green)**

With the shutter-release button pressed partway down -

Glows: focus confirmed

Blinks rapidly: subject is too close

Blinks slowly: focus not confirmed (p. 30)

Flash lamp (orange)

With the shutter-release button pressed partway down -

Glows: flash is charged and ready

Blinks rapidly: flash charging

Blinks slowly: camera-shake warning

ATTACHING THE CAMERA STRAP

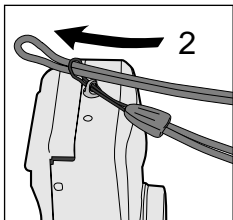
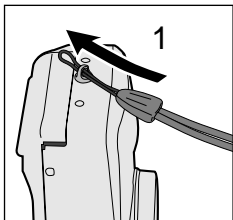

- 1. Pass the small loop of the strap through the strap eyelet on the camera.**
- 2. Pass the the other end of the strap through the small loop and tighten.**

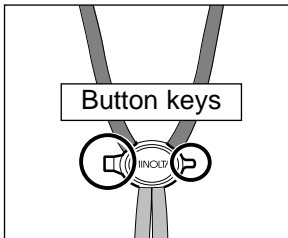

- Button keys are attached to the strap. Use the larger key to open the battery-chamber door, and the smaller key to push the manual-rewind button.

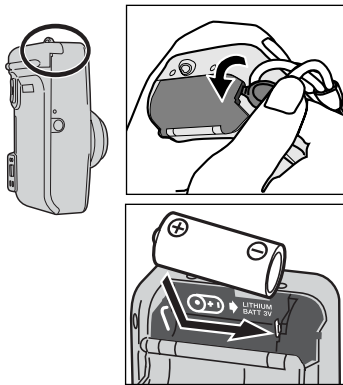

The camera uses one 3-volt CR123A or DL123A lithium battery.

- 1. Open the battery-chamber door using the larger button key on the camera strap.**
- 2. Insert the battery. The positive and negative battery terminals should be orientated as illustrated on the diagram in the battery chamber. Snap the door closed.**

- Quartz-date model: after installing the battery, the date and time must be set, see page 59.
- When changing batteries, always turn the camera off.

BATTERY-CONDITION INDICATOR

Each time the camera is turned on, an indicator will appear on the data panel to indicate the power status of the battery.

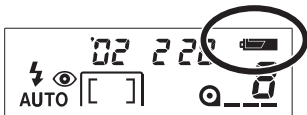

The indicator briefly appears. Power is sufficient for all camera operations.



The indicator blinks. Power is sufficient for camera operation, but the battery must be replaced soon.



The indicator blinks and no other indicators are displayed on the data panel. The shutter will not release. Replace the battery immediately.

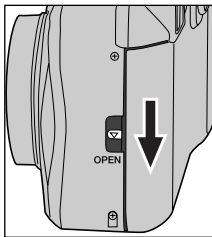
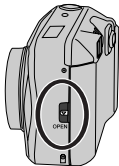

1. Slide the back-cover release down to open the back cover.

- Before opening the back cover, look through the film window to confirm that film is not currently loaded.

- If the back cover does not open, turn the camera off and on to release the film-chamber lock.
- Use only DX-coded 35mm film rated between ISO 25 and 3200.
- Do not use Polaroid instant 35mm film. Winding problems may result.
- ISO 400 film is recommended for best results.
- Always load and unload the film in subdued light.

LOADING THE FILM

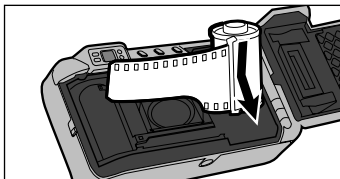

2. Place the film cartridge into the film chamber.

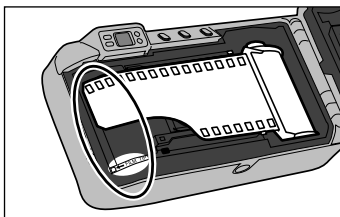

3. Extend the film leader to the film-tip mark. The film must lay flat.

- If the film tip extends beyond the index mark, push the excess film back into the cartridge.



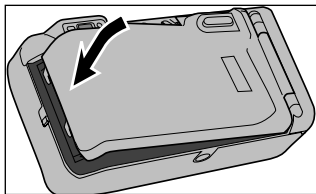

4. Close the back cover.

- The film automatically advances to the first frame and “1” appears in the data-panel frame counter.
- If the film has been loaded improperly, “0” will blink on the frame counter and the shutter will not release. Open the back cover and repeat the loading procedure.
- Once the film is loaded, the battery-chamber lock will engage preventing the back cover from being accidentally opened until the film is rewound.

FULLY AUTOMATIC OPERATION

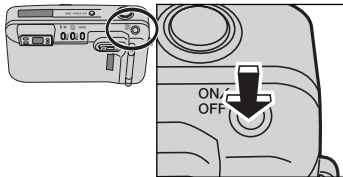

1. Press the main switch to turn the camera on.

- To conserve battery power, the auto-power-off function will turn the camera off eight minutes after the last operation.
- Do not obstruct or hold the lens barrel.

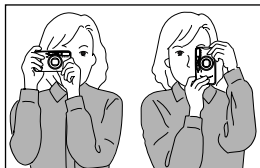

2. Hold the camera steadily. Do not cover the flash, lens, or AF windows with your fingers.

- For vertically framed pictures, turn the camera so the flash is to the top.
- When the camera is brought to your eye, the eyepiece sensors automatically activate the camera's focus and exposure systems.

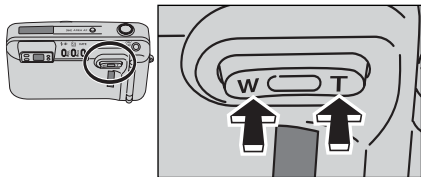

3. Look through the viewfinder and press the zoom lever to zoom the lens.

- The viewfinder will adjust to match the lens' field of view.

T(elephoto): zoom in



W(ide angle): zoom out

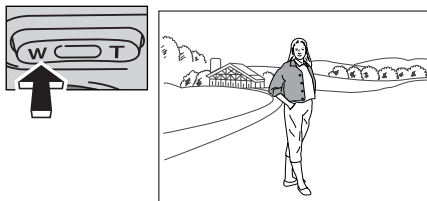

FULLY AUTOMATIC OPERATION

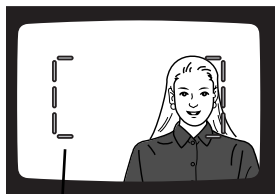

Area-AF frame

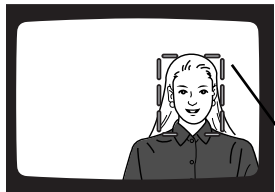

Focus-area indicator

4. Place the subject within the Area AF frame. The focus frame will automatically change to a focus-area indicator to confirm the subject.

- The Area-AF mode (p. 37) is automatically set when the camera is turned on.
- The focus-area indicator shows the area the camera will focus on.
- The shape of the focus-area indicator varies with the subject.

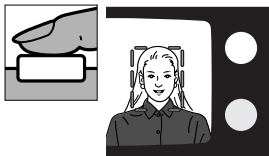

5. Press the shutter-release button partway down.

- The status of the AF system and flash are indicated by the lamps next to the viewfinder.



Focus lamp (green)

Glow: focus confirmed

Blinks rapidly: subject is too close

Blinks slowly: focus not confirmed (p. 30)

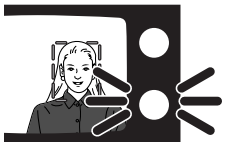

Flash lamp (orange)

Glow: flash is charged and ready

Blinks rapidly: flash charging

Blinks slowly: camera-shake warning

FULLY AUTOMATIC OPERATION

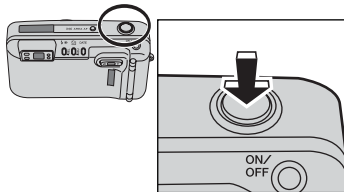

- 6. When the green focus lamp glows, press the shutter-release button all the way down to take the picture.**
- Press the shutter-release button with slow, steady pressure.
 - The film automatically advances to the next frame.
 - Always turn the camera off after use.

AREA-AF FOCUS-AREA INDICATOR

BASIC OPERATION

As long as the subject is located within the Area-AF focus frame, even if it is not centered, the camera will automatically locate the subject and indicate it with the focus-area indicator. The shape of focus-area indicator varies with the subject shape, see the sample illustrations below.

Portrait

(The camera focuses on the two foreground subjects and not on infinity.)



Group shot



An off-center portrait



Landscape



FOCUS LOCK - AREA AF

The focus-lock function allows the camera to be focused on a certain subject and then the picture can be recomposed to arrange the subject at a different position within the image area.



1. With focus-area indicator around the subject, press and hold the shutter-release button partway down.

- The green focus lamp will glow steadily to indicate the focus is locked. If the focus lamp blinks, reposition the camera and repeat the operation.



2. Without lifting your finger, recompose the image in the viewfinder. Press the shutter-release button all the way down to take the picture.

- The focus lock will be canceled if the shutter button is released.

FOCUSING RANGE

BASIC OPERATION

The subject must be within the focusing range of the camera. The minimum focusing distance varies with the focal length of the lens.

	Wide-angle (37.5 mm)	Telephoto (140/160 mm)
140 model	60 cm - ∞ (2.0 ft - ∞)	80 cm - ∞ (2.6 ft - ∞)
160 model		95 cm - ∞ (3.1 ft - ∞)

If the subject is too close, the green focus lamp blinks rapidly and the shutter is locked. The subject must be beyond the minimum focusing distance. If the subject is extremely close, the green focus lamp may blink slowly and the shutter will release, but the focus will not be sharp.

SPECIAL FOCUSING SITUATIONS

The camera may not be able to focus in certain situations. At this time, the focus-lock function (p. 28, 41) can be used to focus on an object at the same distance as your subject, and then the image can be recomposed to take the picture.



When your subject is near a very bright object or area.



When two subjects overlap in the focus frame.

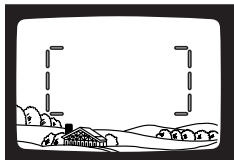

When a low-contrast area fills the focus frame.

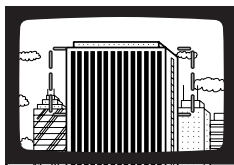

When the subject is composed of a regular repeating pattern.

The green focus lamp will blink slowly to warn that focus cannot be confirmed. The shutter can be released and the focus will be set to infinity; when using the flash, the focus is set between 2.3 - 6.8m (7.5 - 22.3 ft.) depending on the focal length used. Under certain conditions with regular repeating patterns, the green focus lamp may blink rapidly and the shutter will be locked.

FOR CLOSER SUBJECTS

Close-framing guide

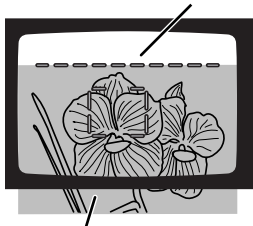

Actual image (shaded area)

Because of parallax, the image seen in the viewfinder and the image recorded with the camera are not exactly the same. Parallax becomes significant with close subjects. A close-framing guide automatically appears in the viewfinder when the image needs to be recomposed to eliminate the effect of parallax. The close-framing guide appears in Area AF, spot AF, and target AF.

If the subject is too close, the green focus lamp blinks rapidly and the shutter is locked. If the subject is extremely close, the green focus lamp may blink slowly and the shutter will release, but the focus will not be sharp.

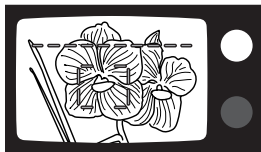

1. With the focus-area indicator on the subject, press and hold the shutter release button partway down.

- The green focus lamp should glow to confirm the focus is locked.

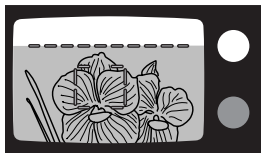

2. While pressing the shutter-release button partway down, recompose the picture so that the top of the subject falls below the close-framing guide. Press the shutter-release button all the way down to take the picture.

REWINDING THE FILM

The camera automatically rewinds the film after the last exposure is taken.



When the cartridge mark blinks on the data panel, the film has been rewound. Open the back cover and remove the film.

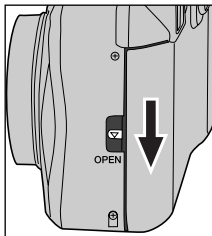

- The film-chamber lock is release during rewind. Do not open the back cover until the cartridge mark blinks on the data panel. Never force the back of the camera open.

- If the rewind motor stops before the film has been completely rewound, all the indicators on the data panel will blink. Remove and insert the battery .
- Although more pictures than specified on the film package may be taken, the film processor may only print the number specified on the film cartridge.

MANUAL REWIND

The film can be rewound before the roll is finished.

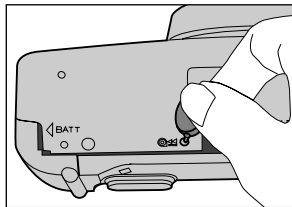

Gently press the manual-rewind button using the small button key on the strap (p. 16).

SELECTING THE AF MODE

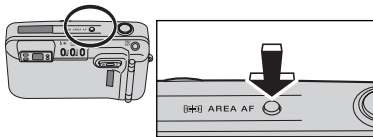

Three auto focus (AF) modes can be selected: Area AF, spot AF, and target AF.

Press the AF mode button until the desired AF indicator appears on the data panel.

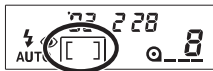

Area AF (p. 37)



Spot AF (p. 40)



Target AF (p. 42)

- Spot-AF and target-AF mode is reset to Area AF when the camera is turned off.

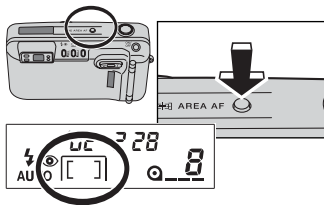

1. Press the AF mode button until the Area-AF indicator appears on the data panel.

2. Place the subject within the Area-AF frame.

- The focus frame will automatically change to a focus-area indicator to confirm the subject.

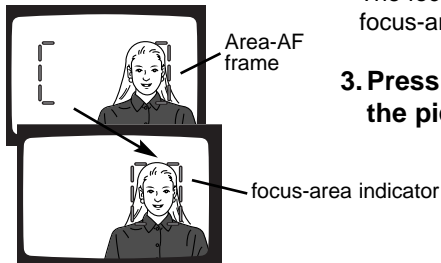

3. Press the shutter-release button to take the picture.

FOCUS-AREA INDICATOR CONTROLS

The display of the focus-area indicator can be controlled with a custom function.

CUS_t-1:1 - The focus-area indicator automatically appears when looking through the viewfinder.

CUS_t-1:2 - The focus-area indicator appears when the shutter-release button is pressed partway down.

CUS_t-1:3 - The focus-area indicator is canceled and will not be displayed.

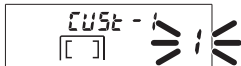
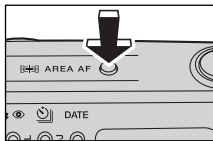

1. Press and hold the AF mode button for about two seconds until “CUST-1” appears on the top of the data panel.

- The number blinking in the frame-counter area is the current custom setting. The initial setting is CUS_t 1:1.

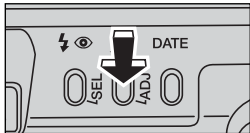

2. To change the setting, press the adjust button or zoom lever until the desired setting number is displayed.

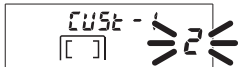

3. Press the AF mode button once to enter the new setting.

- The camera will return to the shooting mode automatically after five seconds. Pressing the AF mode button again or pressing the shutter-release button partway down will also return the camera to the shooting mode.
- The new custom setting will remain in effect even if the camera is turned off or the battery is changed.

SPOT AF

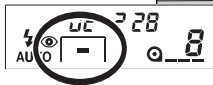
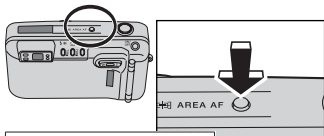

Spot-AF focus frame

The camera focuses on a subject within the spot AF frame. This mode can be used to single out a specific subject from a group.

- 1. Press the AF mode button until the spot-AF indicator appears on the data panel.**
 - The spot-AF focus frame appears in the viewfinder.
- 2. Place the subject in the spot-AF focus frame. Press the shutter-release button partway down to lock the focus.**

The focus-lock function allows the camera to be focused on a certain subject and then the picture can be recomposed to arrange the subject at a different position within the image area.



1. With subject in the focus frame, press and hold the shutter-release button partway down.

- If the green focus lamp glows steadily the focus is locked. If the focus lamp blinks, repeat the operation.

2. Without lifting your finger, recompose the image in the viewfinder. Press the shutter-release button all the way down to take picture.

- The focus lock is canceled when the shutter button is released.

TARGET AF

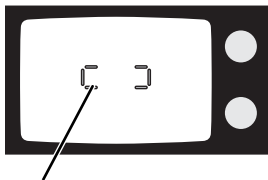
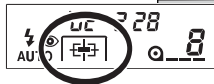
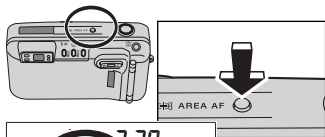

Target-AF focus frame

The target AF is ideal for moving subjects. The camera continually calculates the focus even when the shutter-release button is held partway down. Predictive focus control ensures someone moving toward the camera will be in focus; predictive focus control adjusts the focus during the slight delay between the time the shutter button is pressed and the exposure is made.

1. Press the AF mode button until the target-AF indicator appears on the data panel.

- The target-AF focus frame appears in the viewfinder.

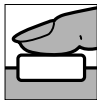

2. Place the subject in the target-AF focus frame.

3. Press and hold the shutter-release button partway down until the green focus lamp glows.

- Target AF has no focus-lock function. The camera continuously calculates focus while the shutter button is held partway down.
- Predictive focus control is activated when the focus lamp glows.
- If the subject becomes too close, the green focus lamp blinks rapidly and the shutter will not release. Repeat the procedure from step 2.

4. Press the shutter-release button all the way down to take the picture.

SELECTING FLASH MODE

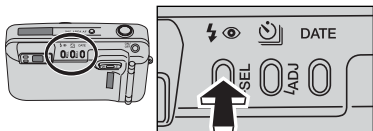

Press the flash-mode button until the desired flash-mode indicator appears on the data panel.

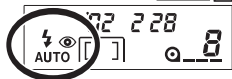

The following flash modes can be selected:



Autoflash (p. 47)



Autoflash with red-eye reduction (p. 48)



Fill-flash (p. 49)



Flash cancel (p. 50)



Night portrait (p. 51)



Exposure compensation (p. 52)
(160 model only)

- When the camera is turned off, the fill-flash, flash cancel, night portrait, or exposure compensation mode will be reset to autoflash or autoflash with red-eye reduction, whichever of the two modes was set last.

FLASH RANGE

The flash range depends on the film speed and focal length in use. Because of the optical system, the flash range is not the same at the lens' wide-angle position as it is at the telephoto position. To ensure proper exposure, the subject must be within the flash range.

Focal length Film speed	37.5 mm	140 mm (140 model)	160 mm (160 model)
ISO100	0.6 - 4.6 m (2.0 - 15.1 ft)	0.8 - 2.1 m (2.6 - 6.9 ft)	0.95 - 2.0 m (3.1 - 6.6 ft)
ISO400	0.6 - 9.2 m (2.0 - 30.2 ft)	0.8 - 4.2 m (2.6 - 13.8 ft)	0.95 - 4.0 m (3.1 - 13.2 ft)

The distances are based on use with color negative film.

AUTOFLASH

ADVANCED OPERATION

The flash will fire automatically in low-light or back-lit situations.

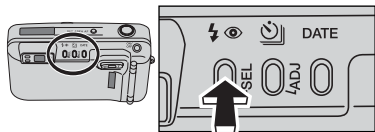

Press the flash-mode button until the autoflash indicator appears on the data panel to set the flash mode.

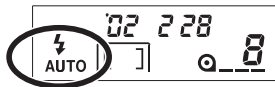

- When the orange flash lamp blinks quickly, the flash is charging. The shutter cannot be released until the flash is charged; the orange flash lamp will glow.

AUTOFLASH WITH RED-EYE REDUCTION

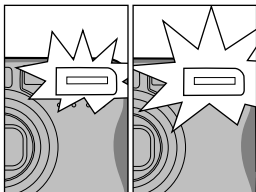

Pre-flash

Main flash

The flash will fire a few short bursts before the main flash burst to reduce red-eye; an effect caused by light reflected from the retina. Used in low-light condition when taking photographs of people or animals, the pre-flashes contract the pupils of the subject's eyes. The flash will fire automatically in low-light or back-lit situations.

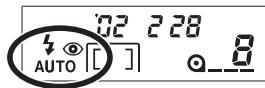
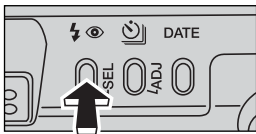

Press the flash-mode button until the autoflash-with-red-eye-reduction indicator appears on the data panel to set the flash mode.

- Warn your subject not to move until all the flash bursts have ended.

FILL-FLASH

ADVANCED OPERATION



The flash fires with each exposure regardless of the amount of ambient light. Fill-flash can be used to reduce harsh shadows caused by strong direct light or sunshine.

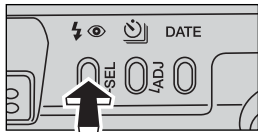

Press the flash-mode button until the fill-flash indicator appears on the data panel to set the flash mode.

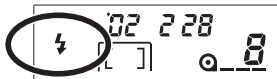

FLASH CANCEL



The flash will not fire in this mode. Use flash cancel when flash photography is prohibited, natural light is desired to illuminate the subject, or the subject is beyond the flash range. The camera-shake warning may appear in this mode.

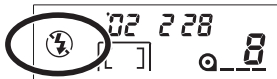
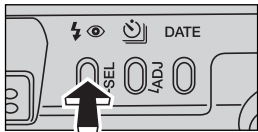

Press the flash-mode button until the flash-cancel indicator appears on the data panel to set the flash mode.

- The orange flash lamp may blink slowly as a camera-shake warning. Camera shake is a slight blurring of the image caused by slight hand motions during long exposures. To eliminate camera shake, use the flash or place the camera on a tripod.



In night-portrait mode, the camera balances the flash and existing light exposure so you can take beautiful portraits at sunset or at night. The flash will fire with each exposure regardless of the amount of ambient light. Red-eye reduction is used with the night-portrait mode.

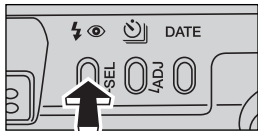

Press the flash-mode button until the night-portrait indicator appears on the data panel to set the flash mode.

- Warn your subject not to move after the flash burst as the shutter may still be open for the background exposure. Because of long exposure times, the use of a tripod is recommended



EXPOSURE COMPENSATION (160 MODEL ONLY)



high-key subjects

The multi-segment metering can expose for most situations: back lighting, and directly lit snow scenes. However, under certain conditions the meter can be deceived by high-key scenes like white interiors or foggy landscapes. This mode increases the exposure by 1.5 Ev. The flash is disabled.

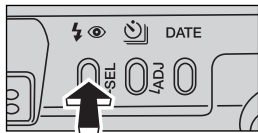

Press the flash-mode button until the exposure-compensation indicator appears to set the mode.

- The orange flash lamp may blink slowly as a camera-shake warning. Use the flash or place the camera on a tripod.

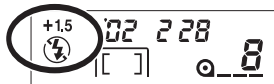

The self-timer is used for taking self-portraits. The self-timer delays release of the shutter for approximately 10 seconds after the shutter-release button is pressed.

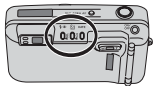

1. With the camera on a tripod, press the drive-mode button until the self-timer indicator appears on the data panel.

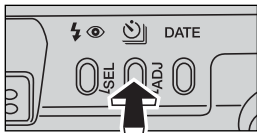

2. Frame the subject as described in the manual.

- Focus lock can be used with Area AF and spot AF.
- With target AF or when focus lock is not used, the focus is set just before the exposure. Make sure the subject is positioned inside the focus frames.

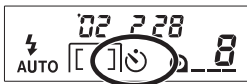

SELF-TIMER

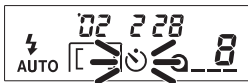
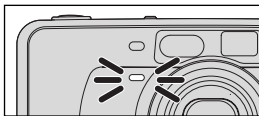

3. Press the shutter-release button all the way down to begin the countdown.

- The self-timer indicator will blink on the data panel. The self-timer lamp on the front of the camera will blink slowly during the countdown, then rapidly just before the shutter is released.

- To cancel the self-timer, press the drive-mode button again or turn the camera off.
- Self-timer is automatically canceled after the shutter is released.

CONTINUOUS ADVANCE (160 MODEL) *ADVANCED OPERATION*



In this mode, the camera continuously takes pictures as long as the shutter-release button is held down. The camera will take one picture every 2.2 seconds. When the flash is used, the rate may be slower because the flash must recharge between frames.

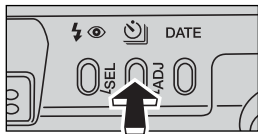

- 1. Press the drive-mode button until the continuous-advance indicator appears on the data panel.**



CONTINUOUS ADVANCE (160 MODEL ONLY)



2. Frame the subject as described in the manual.

3. Press the shutter-release button all the way down and hold to begin taking pictures.

- Focus will be adjusted between exposures.
- Continuous advance remains in effect until the drive mode is reset.
- When using target AF, predictive focus control is only active for the first frame of the series.

FOR OWNERS OF THE QUARTZ-DATE MODEL

The quartz-date model has date and time imprinting and remote-control operation.

DATE AND TIME IMPRINTING

The imprinting feature enables the date or time to be printed onto the lower-right portion of the picture. The date is recorded as the film is advanced to the next frame. The last picture on the roll may not be imprinted. The calendar is programmed through the year 2099.

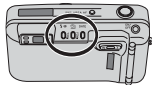

BUTTONS FOR THE DATE FUNCTION



Select button

Adjust button

Date button

Continued on next page.

FOR OWNERS OF THE QUARTZ-DATE MODEL

IMPRINTING THE DATE OR TIME

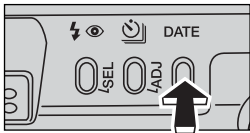

Press the date button to select the date imprinting format.

- The display will change as follows:



- If the date/time display is blinking, the calendar and clock need to be reset (p. 59). No information will be imprinted until the date and time are entered.

SETTING THE DATE OR TIME

Note: the date and time must be reset each time the battery is replaced.

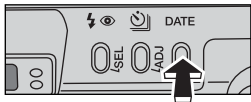

1. Turn the camera on. Press the date button until "SEt" appears on the data panel.



2. Press the select (SEL) button until the item to be adjusted blinks.

- Each time the select button is pressed, the next item on the calendar and clock blinks. The sequence is:

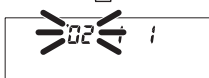
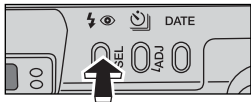

YY → MM → DD → hh → mm → The display stops blinking

FOR OWNERS OF THE QUARTZ-DATE MODEL

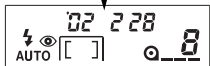
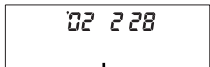
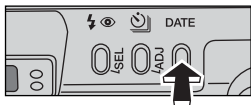
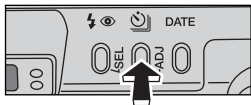

3. Press the adjust (ADJ) button or zoom lever to change the blinking item.

- The numerals continues to change as long as the button is held down.
- Pressing the W side of the zoom lever counts down, the T side counts up.

4. Repeat steps 2 and 3 until all items in the date and time display are correct.

5. Press the date button to set the date and time.

- The camera will return to the shooting mode automatically after five seconds. Pressing the date button again or pressing the shutter-release button partway down will also return the camera to the shooting mode.

- Pressing the select (SEL) button until the date/time display stops blinking can also set the calendar and clock.

CHANGING THE DATE FORMAT

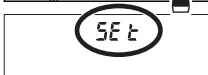

1. Press the date button until "SEt" appears on the data panel.

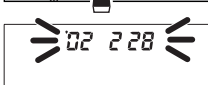

2. Press and hold the select (SEL) button for more than 2 seconds until all items on the date display blink.

FOR OWNERS OF THE QUARTZ-DATE MODEL

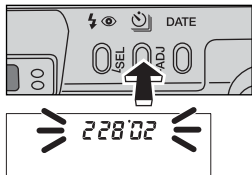

3. Press the adjust (ADJ) button or zoom lever to change the display format.

- The date format changes as follows:
`Y M D → M D`Y → D M`Y

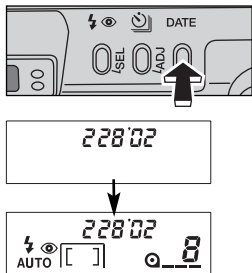

4. Press the date button to set the date format.

- The camera will return to the shooting mode automatically after five seconds. Pressing the date button again or pressing the shutter-release button partway down will also return the camera to the shooting mode.
- Pressing the select (SEL) button until the date/time display stops blinking can also set the date format.

REMOTE CONTROL OPERATION

The quartz-date model can be controlled by the IR remote control RC-3 (sold separately). The remote control allows remote camera operation up to 5 meters (16.5 feet) away.

NAMES OF PARTS

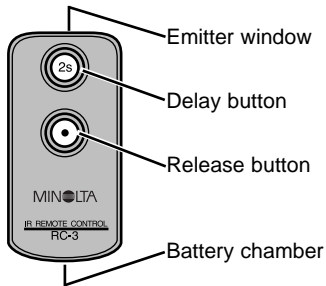

Continued on next page.

FOR OWNERS OF THE QUARTZ-DATE MODEL

TAKING PICTURES USING THE REMOTE CONTROL

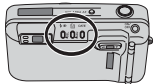

1. Place the camera on a tripod. Point the camera so that the subject is within in the focus frames.

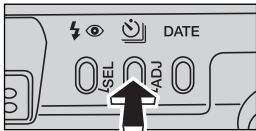

2. Press the drive-mode button until the remote-control indicator appears on the data panel



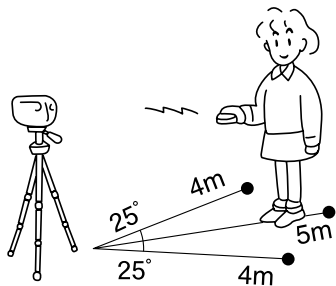

3. Point the remote control toward the front of the camera and press either the release button (•) or the delay button (2s) to take the picture.

- If the release button (•) is pressed, the self-timer/remote-control lamp on the front of the camera will blink once before the picture is taken. If the delay button (2s) is pressed, the lamp will blink for two seconds before the picture is taken.

FOR OWNERS OF THE QUARTZ-DATE MODEL

- To save power, the camera automatically shuts down if the shutter is not released in approximately 8 minutes.
- Under fluorescent or extremely bright lighting, or with backlit subjects, the remote control may not operate or the effective distance may be reduced.
- The remote control mode will remain in effect after the picture has been taken. Press the drive-mode button to reset the drive mode, or turn the camera off.

FOCUS LOCK IN REMOTE CONTROL MODE

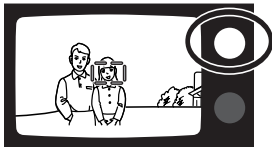

Focus lock can be used in Area AF or spot AF.

1. Select remote-control mode using the drive-mode button.

2. Place the subject in the focus frames and press the shutter-release button partway down to confirm the focus; the green focus lamp will glow and remain lit.

- If the focus lamp does not remain lit after pressing the shutter-release button partway down, the focus was not locked. Repeat the procedure.
- To cancel the focus lock, press the shutter-release button partway down again or press the zoom lever.

FOR OWNERS OF THE QUARTZ-DATE MODEL



3. Recompose the picture.

- The focus frames or focus-area indicator will disappear after releasing the shutter button. The focus lamp will remain lit indicating the focus is locked.

4. Point the remote control toward the front of the camera, press either the release button (•) or delay button (2s).

- The focus lock will remain in effect after the picture is taken allowing multiple remote-control pictures to be made. The green focus lamp will glow to indicate focus lock.
- To cancel focus lock, press the shutter-release button partway down or press the zoom lever.

CHANGING THE REMOTE-CONTROL BATTERY

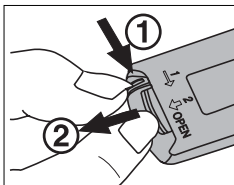

The remote control uses a 3V lithium battery (CR2032). When pressing the remote-control buttons does not release the shutter, the battery needs to be replaced. The supplied battery should be sufficient for approximately ten years of operation.

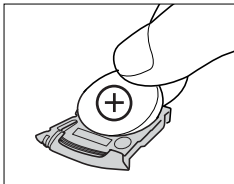

- 1. Pull out the battery chamber as shown and remove the old battery.**
- 2. Insert a new battery into the battery chamber with the positive (+) pole up.**
- 3. Slide the battery chamber into the remote control.**

VIEWFINDER BRIGHTNESS

The relative brightness of the AF frame or focus-area indicator can be adjusted. The brightness of the frame lines will continue to adjust automatically in relation to the new level.

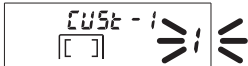
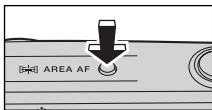

1. Press and hold the AF mode button for about two seconds until “CUST-1” appears on the top of the data panel.

- The number blinking in the frame-counter area is the current custom setting.



2. Press the select button until “CUST-2” appears.

- The blinking number in the frame counter displays the current brightness level. The initial setting is 3. Brightness can be adjusted in five levels from 1 (low) to 5 (high).

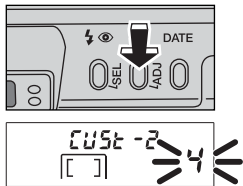

3. Press the adjust button or zoom lever until the desired brightness level is displayed.

4. Press the AF mode button or press the shutter-release button partway down to set the brightness level.

- The data-panel display returns to normal.
- The new brightness level will remain in effect even if the camera is turned off or the battery is changed.

MINOLTA HISTORY

On February 20th, 1962, John Glenn became the first American to orbit the Earth. On board his Friendship 7 spacecraft was a Minolta Hi-matic camera to record that historic event. The 4 hour, 55 minute, and 23 second flight orbited the Earth three times at an average speed of 28,000 kph (17,500 mph).

Mr. Glenn visited our Sakai camera factory in Japan on May 24th, 1963 to plant a palm tree to celebrate the occasion. The palm tree is still in the courtyard of the factory and stands over eight meters tall (26ft).

The camera? It was not lost. It is on display at the Smithsonian Institution's National Air and Space Museum in Washington D.C. This and other objects from John Glenn's Friendship 7 Mercury flight can be found in gallery 210, "Apollo to the Moon."



OPERATING TEMPERATURE AND CONDITIONS

- This camera is designed for use from -10 to 40°C (14 to 104°F).
- Never leave the camera where it may be subjected to extreme temperatures such as in the glove compartment of a car.
- At colder temperatures, the data panel response time will be slow. At higher temperatures, the display will temporarily darken, but will be restored when the temperature normalizes.
- Never subject the camera to extreme humidity.
- To prevent condensation from forming, place the camera in a sealed plastic bag when bringing it from a cold environment into a warm one. Allow it to come to room temperature before removing it from the bag.



CARE AND STORAGE

- When photographing in cold weather, it is recommend that you keep the camera and spare batteries inside your coat to keep them warm when you are not shooting. Cold batteries will regain some of their charge when they warm up.
- This camera is not waterproof, dust-proof, or sand-proof. Care should be taken when using of this camera near water or the beach to protect it from damage caused by water, dust, or sand. Protect the camera from moisture or splashes, especially saltwater spray. Be extremely careful to protect the interior and exterior of the camera and its accessories from sand.

CLEANING

- Keep the AF window clean to ensure accurate focus.
- If the camera body is dirty, gently wipe it clean with a soft, clean, dry cloth.
- To clean the lens surface, first brush away any dust or sand then, if necessary, moisten a lens tissue with lens cleaning fluid and gently wipe the lens in a circular motion, starting from the center.
- Never place lens fluid directly on the lens.
- Never touch the lens surface with your fingers.
- Never use alcohol or solvents to clean the camera.

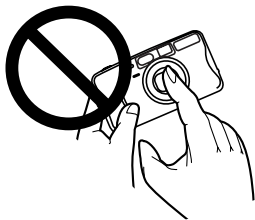

CARE AND STORAGE

STORAGE

When storing the camera for extended periods, please follow these guidelines:

- Store the camera in a cool, dry, well-ventilated area away from dust and chemicals. For very long periods, place the camera in an airtight container with a silica gel drying agent.
- After prolonged storage, always check the camera's operation to make sure it is functioning properly.

BEFORE IMPORTANT EVENTS

- Check camera operation carefully and take test photographs. Purchase a spare battery.
- Minolta is not responsible for any loss which may occur due to an equipment malfunction.

CAMERA ERROR

If all the indicators on the data panel blink, or the data panel is blank and the camera will not function with a recently installed battery, remove and reinsert the battery. If the camera does not resume normal operation, or the camera malfunctions repeatedly, contact an authorized Minolta Service Facility.

QUESTIONS AND SERVICE

- If you have questions about your camera, contact your local camera dealer or write to the Minolta distributor in your area.
- Before shipping your camera for repair, please contact an authorized Minolta Service Facility for details.

TECHNICAL SPECIFICATIONS

Camera Type:	35mm lens-shutter camera	
Lens:	37.5-140mm f/5.4 - 11.7 lens (140 model) 37.5-160mm f/5.4 - 12.4 lens (160 model) 6 elements in 6 groups	
Focusing Range:	(140 model)	(160 model)
	(W): 0.6m - ∞ (2.0 ft - ∞)	0.6m - ∞ (2.0 ft - ∞)
	(T): 0.80m - ∞ (2.6 ft - ∞)	0.95m - ∞ (3.1 ft - ∞)
Film Speed:	Settings	Automatic for DX-coded film. Non-DX coded film set to ISO100.
	Range	ISO 25 to 3200
Metering Range (ISO 100):	(140 model)	(160 model)
	Wide: Ev 3 - 17	Ev 3 - 17
	Tele: Ev 3.9 - 17	Tele: Ev 4.1 - 17
Shutter Speed:	10 - 1/500 sec.	
Flash Range (ISO 100):	(140 model)	(160 model)
	Wide: 0.6 - 4.6 m (2.0 - 15.1 ft.)	0.6 - 4.6 m (2.0 - 15.1 ft.)
	Tele: 0.8 - 2.1 m (2.6 - 6.9 ft.)	0.95 - 2.0 m (3.1 - 6.6 ft.)

- Battery:** One 3-volt CR123A lithium battery
Battery-condition indication: 3-stage indication
Battery performance: approx. 10 rolls based on Minolta's standard test method using 24-exposure rolls with flash for 50% of the exposures.
- Viewfinder:** Magnification: 0.38X - 1.35X (**140 model**); 0.38X - 1.51X (**160 model**)
Field of View: 85% (at 3m)
Eye-relief: 17.3mm from the viewfinder frame
- Dimensions:** 110.5 x 60.5 x 46.5 mm
4.4 x 2.4 x 1.8 in
- Weight:** 195g (6.9 oz.) without battery

Specifications are based on the latest information available at the time of printing and are subject to change without notice.

Minolta Co., Ltd.

**Minolta Europe GmbH
Reparatur/Repair**

Minolta France S.A.

Minolta (UK) Limited

Minolta Austria Ges. m.b.H.

**Minolta Camera Benelux B.V.
Belgian Branch**

Minolta (Schweiz) AG

**Minolta Svenska AB
Finnish Branch**

Minolta Portugal Limitada

Minolta Corporation

Head Office

Los Angeles Branch

Minolta Canada Inc.

Head Office

Vancouver Branch

Minolta Hong Kong Limited

Minolta Singapore (Pte) Ltd.

**Shanghai Minolta Optical
Products Co., Ltd.**

3-13, 2-Chome, Azuchi-Machi, Chuo-Ku, Osaka 541-8556, Japan

Minoltaring 11, D-30855 Langenhagen, Germany

Senator-Helmken-Strasse 1, D-28197 Bremen, Germany

365 Route de Saint-Germain, F-78420 Carrieres-Sur-Seine, France

7 Tanners Drive, Blakelands, Milton Keynes, MK14 5BU, England

Amalienstrasse 59-61, A-1131 Wien, Austria

Zonnebaan 39, P.O. Box 6000, NL-3600 HA Maarssen, The Netherlands

Prins Boudewijnlaan 1, B-2550 Kontich, Belgium

Riedstrasse 6, CH-8953 Dietikon, Switzerland

Albygatan 114, S-171 54 Solna, Sweden

Niittykatu 6 PL 37, SF-02201 Espoo, Finland

Av. do Brasil 33-A, P-1700 Lisboa, Portugal

101 Williams Drive, Ramsey, New Jersey 07446, U.S.A.

11150 Hope Street Cypress, CA 90630, U.S.A.

369 Britannia Road East, Mississauga, Ontario L4Z 2H5, Canada

230-3771 Jacombs Road, Richmond, B.C. V6V 2L9, Canada

Room 208, 2/F, Eastern Center, 1065 King's Road, Quarry Bay, Hong Kong

10, Teban Gardens Crescent, Singapore 608923

368 Minolta Road, Songjiang, Shanghai, China