MAGNUM OPUS[®]

ALL-CHINA GRAVITY DISCHARGE TOILET

OWNER'S MANUAL

3000 Series Toilets



! WARNING

This manual must be read and understood before installation, adjustment, service, or maintenance is performed. Modification of this product can result in property damage.



Dometic Corporation • Sanitation Systems
13128 State Rt 226, PO Box 38
Big Prairie, OH 44611
SeaLand Product Customer Service: 1-800-321-9886
(8:00 a.m. - 5:00 p.m. ET)

TABLE OF CONTENTS

Toilet Model Identification	2	Deodorants and Special Tissue	6
Ordering Parts	2	Flush Mechanism Components	7
Important Information Before Operation	3	Troubleshooting	8 – 9
Toilet Controls	3	Manual Flush Operation	9
Operating Instructions	4	Electrical Troubleshooting	10 – 12
Automatic Flush Operation Timing Chart	5	Wiring Diagram	12
Proper Cleaning and Maintenance	5	Customer Service	13
Winterizing	6	Notes	14 – 15
Spare Parts	6	Limited Warranties	16



WARNING – ELECTRICAL SYSTEM.
Turn off electrical power before servicing.



WARNING – MOTOR STARTS AUTOMATICALLY.
Turn off electrical power before servicing.

Read and understand the complete contents of this manual before operating or servicing the toilet. Failure to follow these precautions may result in damage to the toilet.

TOILET MODEL IDENTIFICATION

The model identification label is located on the inside wall of the toilet under the access cover. It will show the model number and serial number.

DOMETIC CORPORATION

P.O. BOX 38, 13128 STATE RT 226 (800) 321-9886
BIG PRAIRIE, OH 44611 USA

MODEL NO. **000**

SERIAL NUMBER

000000

ORDERING PARTS

Dometic is ready to assist you in the event service is required. Before calling, please have the following information available. Your cooperation in having this information ready is appreciated and allows us to better meet your needs. Please refer to the Parts Distributor list in the Customer Service section.

1. Toilet Model Number
2. Serial Number
3. Part Number, Description and Quantity (see Parts List)

Magnum Opus, SeaLand and Flush and Forget are registered trademarks of Dometic Corporation.

IMPORTANT INFORMATION BEFORE OPERATION

1. Fill freshwater tank and add deodorant to holding tank through toilet bowl.
2. Make sure all guests understand the operation of the toilet system and the flushing instruction label is easy for guests to read. **This label is located under the seat, and is easily read when the seat is raised.**
3. Shut off the toilet system before servicing and do not leave the vehicle with toilet system circuit breaker on.
4. **Never use drain openers, alcohol, solvents, etc. in the toilet.**
5. If the toilet does not function properly, refer to the Troubleshooting section of this manual and repair as necessary. If problem persists, contact your local SeaLand product dealer or see the Customer Service section of this manual.

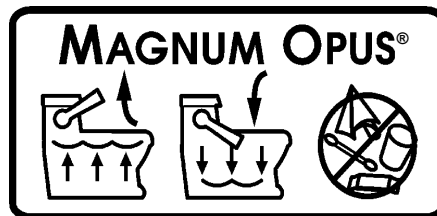

FLUSH and FORGET® OPERATION

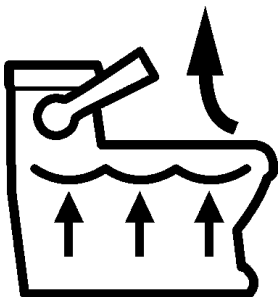
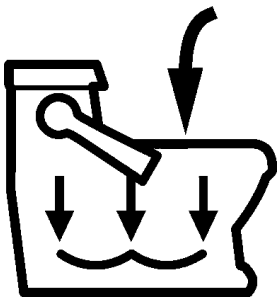
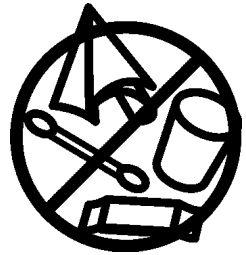
<p>1. To add water to the toilet before using (if necessary), raise flush handle until desired water level is reached. (Water flow will stop automatically after a pre-programmed period of time).</p> 	<p>2. To flush toilet, press flush handle down. Water will flow into bowl for two seconds, then flush ball will open. Toilet will not flush again until water refill cycle is complete.</p> 	<p>3. Do not dispose of sanitary napkins or other non-dissolving items in toilet, such as facial tissue or paper towels. These items can cause plugging of the system.</p> 
-------------------------------------------------------------------------------------------------------------------------------------------------------------------------------------------------------------------------------------------------------------------------------------------	--------------------------------------------------------------------------------------------------------------------------------------------------------------------------------------------------------------------------------------------------------------------------------	-----------------------------------------------------------------------------------------------------------------------------------------------------------------------------------------------------------------------------------------------------------------

TOILET CONTROLS

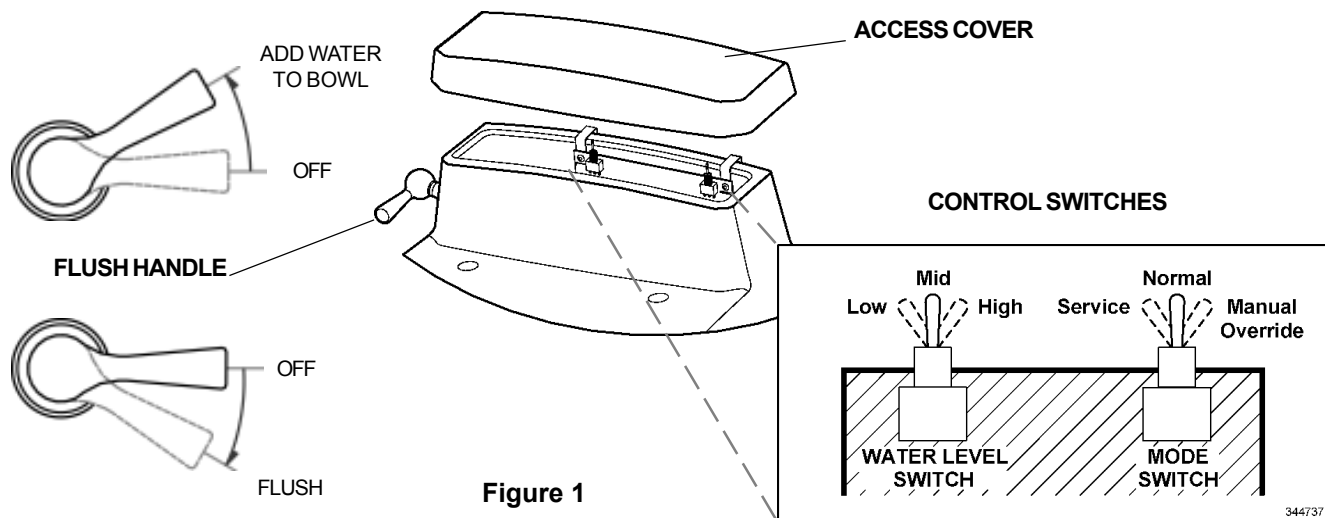

OPERATING INSTRUCTIONS

1. Adding More Water To Toilet Bowl

Pull up the handle until the desired water level is attained. To prevent overflowing the toilet, a timer inside the control module limits the amount of water that can be added.

2. Flushing The Toilet

Push the handle down for a moment, then release it. Holding the handle down will not prolong the flush cycle nor start a new flush cycle. The lever must be allowed to return to the OFF position before another flush can occur.

3. Selecting Automatic Water Levels

The Water Level switch is located under the access cover. Carefully lift up on the front of the cover to access the Water Level switch. There are three water refill levels available. The microprocessor-controlled water valve will refill the toilet bowl according to your Water Level selection (see Figure 1, page 3).

To reinstall the access cover, set the cover on top of the toilet and press down. This will lock the cover in place and prevent it from coming loose during rough travel.

LOW Level

Use this setting to conserve water. This level also may be desirable to reduce the chance of water splashing out of the bowl during sudden stops and starts or when traveling. If more water is needed for flushing, lift up on the flush handle. Water flow will stop after nine seconds to prevent overflow.

MID Level

Use this position to keep the toilet bowl clean, especially when family and friends may be using the toilet. If more water is still needed for flushing, raising the flush lever will provide up to six seconds of additional water refill time.

HIGH Level

Use this position if the MID level does not provide a clean toilet bowl. This position is not recommended while the vehicle is underway. If more water is still desirable for flushing, raising the flush handle will provide up to three seconds of additional water refill time.

4. Mode Switch

The Mode switch is located on the right side of the printed circuit board. It lets you switch between three function settings:

NORMAL

Use this setting for flushing the toilet.

SERVICE

Use this position for cleaning the toilet bowl and flush ball seal. The flush ball will open automatically and remain open in this position. Lifting up the flush handle provides water.

MANUAL OVERRIDE

Use this position to flush the toilet manually in the event of power or battery failure. This switch disconnects the electronic brake in the flush valve motor, and allows manual flushing via the override access hole in the side of the vitreous china base.

Note: The control module allows 15 seconds of water for cleaning. If more water is required, return the switch to the NORMAL position, then back to the SERVICE position.

A safety circuit in the control module monitors flush ball operation. If foreign objects or low voltage prevent the flush ball from closing, this circuit prevents personal injury or damage to the flush valve motor. If this condition occurs, reset the control module by placing the Mode switch into the SERVICE position temporarily, then returning it to the NORMAL position.

AUTOMATIC FLUSH OPERATION TIMING CHART

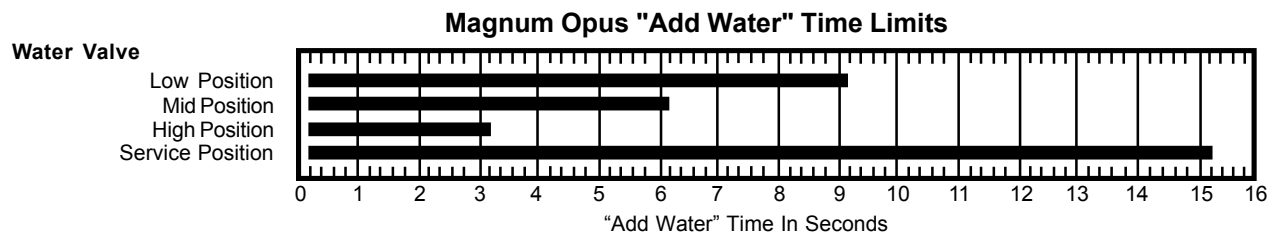
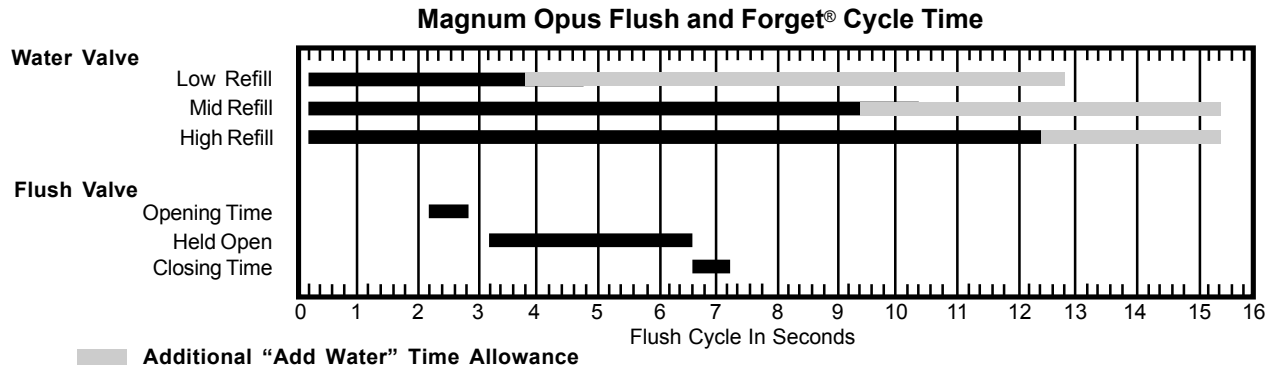

PROPER CLEANING AND MAINTENANCE

The Magnum Opus toilet should be cleaned regularly for maximum sanitation and operational efficiency. You can clean it just as you would a household toilet. **Do not use caustic chemicals, such as drain-opening types, as they will damage the seals.**

BOWL CLEANING: For stubborn stains, use SeaLand Bowl and Seal Cleaner (Fig. A). It's manufactured especially for use with our Magnum Opus toilets. In certain locations where water is hard, a build-up of lime may dull the toilet bowl finish. Restore the shine with this cleaner. If you cannot find our brand in your area, contact SeaLand Product Customer Service for your nearest dealer. If it is not available, you can also use Bar Keepers Friend® cleanser. It is not necessary to vigorously scrub with either product. Please follow label instructions.



SEAL CLEANING: After an extended time, mineral deposits from hard water can build up under the edge of the rubber bowl seal, resulting in a slow leakdown of water from the bowl. To prevent this mineral build-up, periodically clean under the bowl seal with SeaLand Bowl and Seal Cleaner (Fig. B).

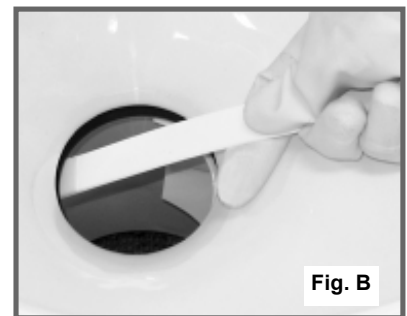

1. Put Mode switch in SERVICE position. Flush ball will open automatically.
2. Apply cleanser onto the seal cleaning tool (supplied with new toilet), and scrub under the seal. Make sure to push bristles between bottom of seal and top of flush ball surface to scrub all parts of seal that come into contact with flush ball.
3. Wait 2-3 minutes.
4. Pull up on flush handle to let water flow into bowl. Use cleaning tool and water to rinse away cleanser and loosened deposits. You can add water for up to 15 seconds in the SERVICE position.
5. Put Mode switch in NORMAL position. Water will flow for a few seconds, then flush ball will close automatically. Water will continue flowing into bowl, making it ready for the next flush.

WINTERIZING

At the end of each traveling season, the Magnum Opus toilet system must be winterized for storage. The following procedure should be used:

1. Pump out waste holding tank.
2. Thoroughly flush toilet system with fresh water.
3. Drain freshwater tank.
4. Add freshwater antifreeze to freshwater tank.
5. Flush freshwater antifreeze and water mixture through toilet and into the waste holding tank. Each installation is different so amounts may vary. User discretion is required to assure adequate protection.
6. Turn off electrical power.

CAUTION: The use of freshwater antifreeze that contains alcohol will result in damage to your sanitation system. Only use propylene glycol freshwater antifreeze that **does not contain alcohol**.

SPARE PARTS

It is recommended that the following spare parts be kept available at all times:

Description	Part Number	Quantity	Description	Part Number	Quantity
Flush Ball Seal Kit	see parts list	1	Water Valve	see parts list	1
Flush Ball	see parts list	1	Vacuum Breaker Assembly	see parts list	1

DEODORANTS AND SPECIAL TISSUE

Your Magnum Opus toilet requires the regular addition of a deodorant product to reduce malodors and to help break down holding tank contents. Several factors should be considered in selecting a deodorant product.

Liquid or Dry: Liquid products obviously work more quickly by readily going into solution. Granulated powder formulations, on the other hand, have the advantage of requiring less storage space and are less likely to leak if the package is inadvertently damaged.

Formaldehyde versus Non-Formaldehyde: Dometic manufactures both types of deodorants. Generally speaking, formaldehyde formulas control odor very effectively at all temperatures and with all degrees of water hardness. SeaLand® Environment-Friendly brand, which is formaldehyde free, is similarly effective.

How Much Deodorant and How to Add It: The deodorant is added directly into the toilet bowl, then flushed into the holding tank. Follow bottle or package instructions. Conditions of extremely warm weather, longer waste holding time and larger tank capacities may require more deodorant treatment. Also, to maintain optimum efficiency in odor control, the waste holding tank should be cleaned thoroughly at least once or more each season, depending on use.

Why Not Use Household Toilet Paper in Your Magnum Opus Toilet? Household tissues often contain adhesives which bond together the paper fibers from which the tissue is made. The adhesives prevent the tissue from breaking apart, and their use in “ultra-low flow” systems can cause system clogging. SeaLand tissue is especially designed for use in low water toilet systems. Its rapid dissolving properties minimize the amount of residual paper in the holding tank and allow deodorizers to work more efficiently.

SeaLand versus Other Brands: SeaLand constantly strives to provide our system owners with effective products that have minimal environmental impact and good value. Many deodorant products do not measure up to our standards of performance and value.



SeaLand® Granulated Deodorant
Six 2-oz. pouches
Part No. 379626002

SeaLand® Liquid Deodorant
Two 8-oz. bottles
Part No. 379224008



SeaLand® Liquid Deodorant - Environment Friendly
32-oz. bottle
Part No. 379114032



SeaLand® Rapid-Dissolving Toilet Tissue
Four 400-sheet rolls
Part No. 379441204



FLUSH MECHANISM COMPONENTS

1. To access base assembly components, remove decorative screw caps and unscrew four bolts that hold china toilet to floor.

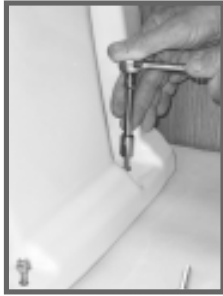

2. Remove access cover. Lift up control module. Disconnect power cable from control module. **Do not** disconnect flush handle cable or base assembly cable.

3. Lift china toilet straight up and set it down close to front of floor flange/ adapter assembly. Turn off water to toilet and disconnect flexible water line at rear of base assembly. The toilet is completely disconnected.

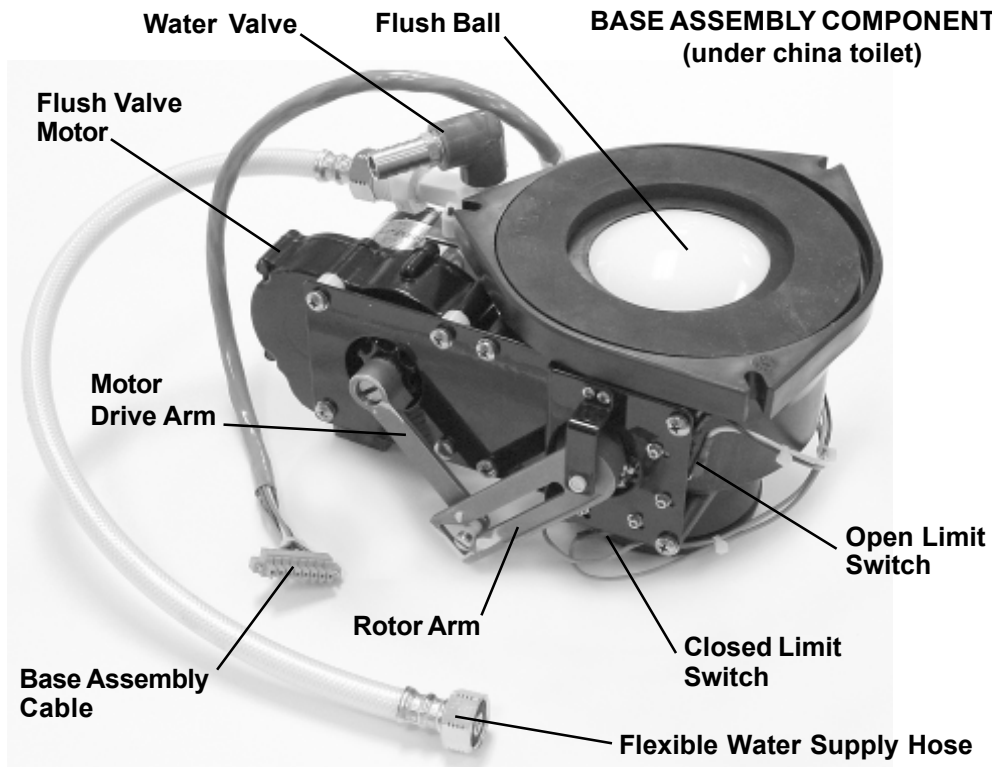
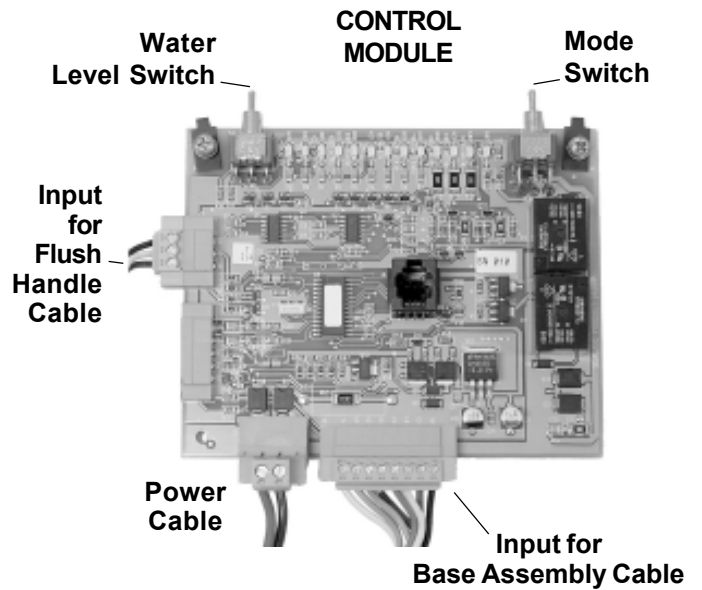
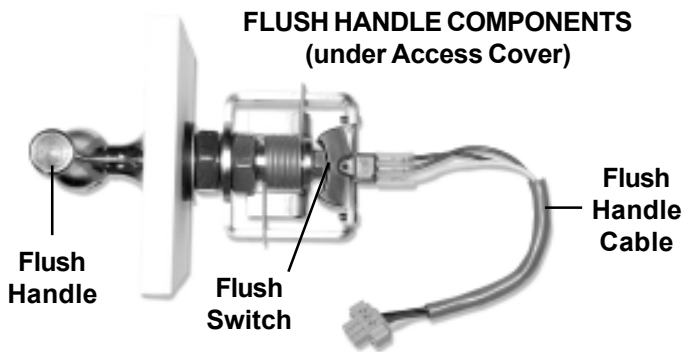

TROUBLESHOOTING

Important: Always turn off electrical power and water to the toilet for disassembly.

Problem	Possible Cause	Service Instructions
1. Toilet emits odor (flush ball open).	<ul style="list-style-type: none"> a. Odor emitting from base of toilet. b. Plugged holding tank vent line. 	<ul style="list-style-type: none"> a. Use SeaLand brand deodorants. b. Clear obstructions from vent line.
2. Water will not stay in bowl.	<ul style="list-style-type: none"> a. Dirt or debris on underside of flush ball seal. b. Worn or damaged flush ball and seal. 	<ul style="list-style-type: none"> a. Put Mode Switch in "Service" position and clean underside of flush ball seal. b. Remove toilet from floor, disassemble bowl from base, and replace flush ball and seal.
3. Water leaks onto floor.	<ul style="list-style-type: none"> a. Toilet loose. b. Defective component under china bowl: vacuum breaker assembly, water hose/fittings, water valve assembly, upper bowl seal, base O-ring, rotor shaft, or plastic base. c. Worn or defective floor flange seal. d. Cracked china bowl. 	<ul style="list-style-type: none"> a. Tighten toilet mounting bolts. b. Remove floor bolts and turn toilet to one side as much as possible, keeping telescoping base in floor flange adapter. Flush toilet to find source of leak. Tighten loose connections or replace defective component. c. Replace seal. d. Replace china toilet.
4. Toilet will not flush and water will not enter bowl.	<ul style="list-style-type: none"> a. Fuse is blown. b. Loose electrical connections. c. Defective Flush Switch. 	<ul style="list-style-type: none"> a. Replace fuse typically located in fuse panel. b. See Electrical Troubleshooting section. c. See Electrical Troubleshooting section.
5. Flush ball will not open, but water enters toilet bowl.	<ul style="list-style-type: none"> a. Defective Flush Switch, limit switches or loose connections. b. Toilet bowl and base are misaligned, causing drive arm to contact inside wall of bowl. 	<ul style="list-style-type: none"> a. See Electrical Troubleshooting section. b. Adjust base-to-toilet bowl connection to eliminate interference.
6. Flush ball will not close.	<ul style="list-style-type: none"> a. Mode Switch is in "Service" position. b. Safety circuit locked flush ball in open position. c. Closed or Open Limit Switch out of adjustment or defective. 	<ul style="list-style-type: none"> a. Return Mode Switch to "Normal" position. b. Reset Control Module by putting the Mode Switch in the "Service" position for 3 seconds, then return to "Normal" position. c. See Electrical Troubleshooting section.
7. Water will not enter bowl in any Water Level setting and when the flush handle is raised to add water.	<ul style="list-style-type: none"> a. Loose electrical connections, defective Water Valve or Control Module. b. No water pressure to toilet. c. Water Valve filter screen is clogged. 	<ul style="list-style-type: none"> a. See Electrical Troubleshooting section. b. Repair water system. c. Remove water line from Water Valve inlet and clean debris from filter screen.
8. Water does not enter toilet bowl properly.	<ul style="list-style-type: none"> a. Insufficient water flow rate at toilet. b. Water Valve clogged. c. Plugged rim wash holes in toilet. 	<ul style="list-style-type: none"> a. Check water flow rate at toilet. Rate should be 2 gpm (7.6 lpm) at toilet. b. Remove and clean screen located inlet of Water Valve. c. Clean holes. If still a problem, replace the toilet bowl.

TROUBLESHOOTING (cont'd)

Problem	Possible Cause	Service Instructions
9. Water leaking from Water Valve.	<ul style="list-style-type: none"> a. Water Valve body cracked due to freeze damage. b. Water line connection is loose or not seated properly. c. Defective Water Valve. d. Stripped threads. 	<ul style="list-style-type: none"> a. Replace Water Valve. b. Insure that threads are not cross-threaded and tighten. c. Replace Water Valve. d. Replace Water Valve.
10. Water will not enter toilet bowl when the Flush Handle is raised to add water.	<ul style="list-style-type: none"> a. Loose electrical connections or defective Flush Switch. 	<ul style="list-style-type: none"> a. See Electrical Troubleshooting section.
11. Water Level Switch has no effect on water level in low or high positions.	<ul style="list-style-type: none"> a. Defective Water Level Switch or Control Module. 	<ul style="list-style-type: none"> a. Replace Control Module.
12. Water will not shut off – toilet overflows.	<ul style="list-style-type: none"> a. Dirt or debris lodged in Water Valve seal. b. Defective Water Valve. c. Defective Control Module. 	<ul style="list-style-type: none"> a. Disassemble and clean Water Valve. b. Replace Water Valve. c. Replace Control Module.
13. Flush ball will not open with Mode Switch in "Service" position.	<ul style="list-style-type: none"> a. Defective Mode Switch or Control Module. 	<ul style="list-style-type: none"> a. Replace Control Module.

MANUAL FLUSH OPERATION

In the event of an electrical failure, the flush ball of the toilet can be manually opened to clear the bowl. We recommend using a long-neck screwdriver or 7/16-in. socket for the operation shown below. **NEVER PRY OPEN THE FLUSH BALL FROM INSIDE THE TOILET BOWL.** Damage to the flush ball and bowl seals may result.

1. Remove access cover from top of china toilet. Place Mode Switch in the "Manual Override" position. This disconnects flush valve motor brake from electrical circuit.

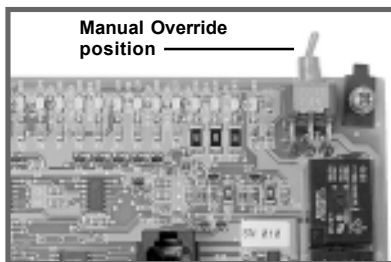

2. Locate hole on side of china toilet. This allows access to the flush valve motor drive arm.



3. Insert screwdriver or 7/16-in. socket through access hole and onto hex head.

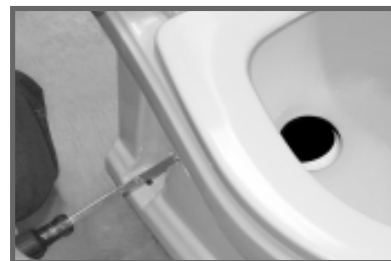

4. Turn screwdriver or socket **counter-clockwise**. This will open flush ball and allow bowl contents to clear. After bowl is clear, turn screwdriver or socket clockwise to return flush ball to original position.

NOTES:

Water will not enter the toilet bowl during manual flush operation.

Place Mode Switch in the "Normal" position before returning to automatic operation.

ELECTRICAL TROUBLESHOOTING

A volt/ohmmeter (VOM) and the Magnum Opus Wiring schematic (page 12) may be required for this section.

Caution: Portions of this section will require that power be applied to the toilet. Keep hands away from the flush ball, motor drive arm and rotor shaft to prevent personal injury during testing and troubleshooting.

The Magnum Opus control module uses a microprocessor to provide all the automatic and timing functions. The control module is on the right side under the access cover on the top of the toilet. The control module has input and output status lights that can be used in troubleshooting the toilet. The program inside the microprocessor is used for both gravity discharge and vacuum-operated toilets.

The program in the microprocessor monitors the input and output signals during a normal flush cycle. If the inputs or outputs do not follow the commands of the program, then the microprocessor may go into a "standby" mode and flash an "error" code. The microprocessor is reset by placing the Mode switch in the "Service" position temporarily, then returning the switch to the "Normal" position.

Status Light	Color	Function
1 Low Level	Green	Water Level Switch in "Low" position.
2 High Level	Green	Water Level Switch in "High" position.
3 Valve Closed	Green	Flush valve Closed Limit Switch engaged.
4 Valve Open	Green	Flush valve Open Limit Switch engaged.
5 Service Mode	Green	Mode Switch in "Service" position.
6 Flush	Green	Flush Handle in "Flush" position.
7 Add Water	Green	Flush Handle in "Add Water" position.
8 High Vac Switch	Green	Always on (vacuum toilet only).
9 Holding Tank Full	Green	Always off (vacuum toilet only).
10 OK to Flush	Green	On when not in flush cycle.
11 Do Not Flush	Green	On during flush cycle. Also provides error codes.
12 Water Valve	Green	Electric water valve energized.
13 +5V	Green	Input power

ERROR CODES

Status Light	No. of Flashes	Pause	Condition
10 OK to Flush	1	.5 sec.	Mode Switch in SERVICE position
11 Do Not Flush	1	2 sec.	VALVE OPEN Limit Switch problem
11 Do Not Flush	2	2 sec.	VALVE CLOSED Limit Switch problem
11 Do Not Flush	4	2 sec.	Flush valve motor relay failure

CONTROL MODULE STATUS LIGHTS

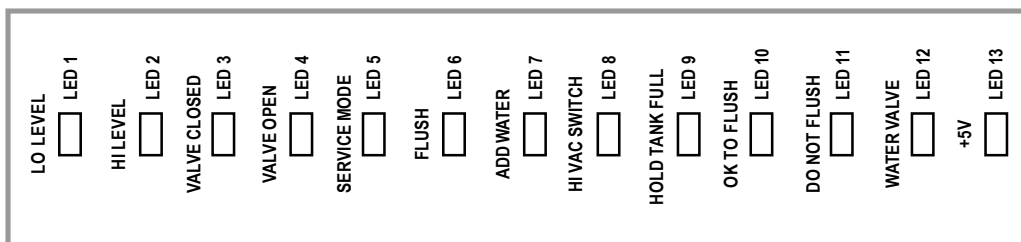

ELECTRICAL TROUBLESHOOTING (cont'd)

ERROR CODE CORRECTIVE PROCEDURES

<i>Condition</i>	<i>Corrective Action</i>
Mode Switch in SERVICE position.	Return Mode Switch to NORMAL position.
Valve Open Limit Switch problem.	With the flush valve fully open, check the "VALVE OPEN" status light. If the light is off , then the Valve Open Limit Switch is out of alignment or defective, or related wiring is defective.
Valve Closed Limit Switch problem.	With flush valve in the fully closed position check the "VALVE CLOSED" status light. If the light is off , then the Valve Closed Limit Switch is out of alignment or defective, or related wiring is defective.
Flush valve motor relay failure. 	Replace control module.

TOILET OPERATION CORRECTIVE PROCEDURES

Symptom: Toilet will not flush and water will not enter toilet bowl.

- LED 13 (+5V) off :
 - Check toilet fuse or circuit breaker.
 - Check for loose or defective wiring between Control Module and DC power source.
 - Check for reverse polarity.
 - If all of above check OK, replace Control Module.
- LED 13 on:
 - Input voltage must be 10V DC or higher.
 - Check for error codes at LED 10 and LED 11. If showing error, reset Control Module using Mode Switch. If not showing error or Control Module does not reset, go to next step.
- Check following status lights on Control Module:
 - LED 3 (Valve Closed): If not on, Closed Limit Switch is out of alignment or defective, or related wiring is defective.
 - LED 9 (Hold Tank Full): If on, replace Control Module.
- Push Flush Handle down (in "Flush" position) – status light LED 6 (Flush) must light up. Then, release Flush Handle, and status light LED 6 should turn off.
 - If LED 6 **did not** follow the commands of the Flush Handle, the Flush Switch or related wiring is defective.
 - If LED 6 did follow the commands of the Flush Handle, go to the next step.

Symptom: Flush Ball will not close.

- Mode Switch in "Service" position. Return the switch to the "Normal" position.
- Foreign object prevented the Flush Ball from closing and safety circuit locked the Flush Ball in the open position. Reset the Control Module by putting the Mode Switch in the "Service" position temporarily, then set in "Normal" position. The Flush Ball should close after 2 seconds. If Flush Ball does not close, go to next step.
- Check for error code at LED 11 (Do Not Flush). If showing error, the Closed or Open Limit Switch is out of adjustment or defective, or related wiring is loose or defective.

Symptom: Water will not enter the toilet bowl during a flush or when the Flush Handle is lifted.

- Place the Water Level Switch in "Low" position and flush toilet. Check status light LED 12 (Water Valve) while lifting up the Flush Handle to add water.
 - If LED 12 comes on, the Water Valve filter screen may be plugged with debris, or the Water Valve and/or its related wiring is defective.
 - If LED 12 remains off, replace the Control Module.

ELECTRICAL TROUBLESHOOTING (cont'd)

TOILET OPERATION CORRECTIVE PROCEDURES (cont'd)

Symptom: Water will not enter the bowl when the Flush Handle is raised to add water.

- Place the Water Level Switch in "Low" position and flush toilet. Check status light LED 7 (Add Water) while lifting up the Flush Handle.
 - If LED 7 comes on, replace the Control Module.
 - If LED 7 remains off, the Flush Switch or its related wiring is defective.

Symptom: Water Level Switch has no effect on water level in "Low" or "High" position.

- Replace the Control Module.

Symptom: Flush Ball will not open when Mode Switch is in the "Service" position.

- Replace the Control Module.

WIRING DIAGRAM

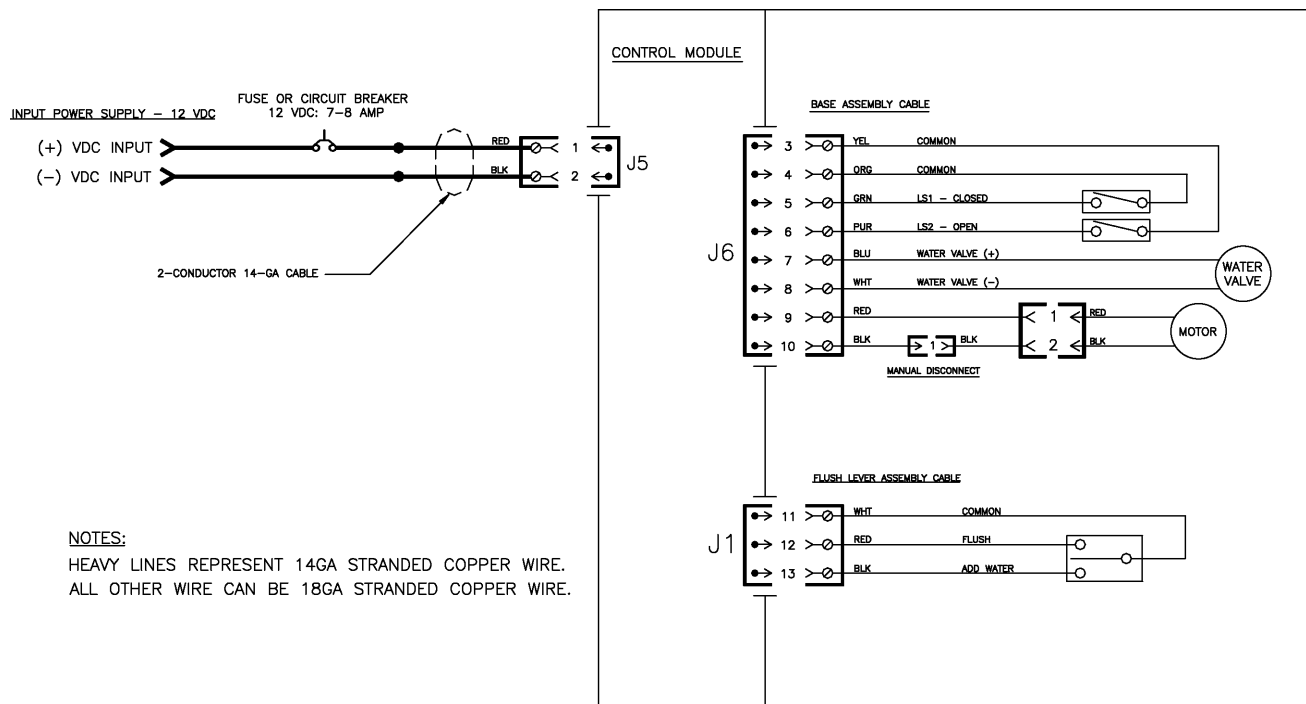

CUSTOMER SERVICE

There is a strong, worldwide network to assist in servicing and maintaining your sanitation system. For the Authorized Service Center near you, please call from 8:00 a.m. to 5:00 p.m. (ET) Monday through Friday. You may also write us at Dometic Corp., P.O. Box 38, Big Prairie Ohio 44611.

Telephone: 1 800-321-9886 U.S.A. and Canada
330-496-3211 International

You may also contact or have your local dealer contact the Parts Distributor nearest you for quick response to your replacement parts needs. They carry a complete inventory for the SeaLand product line.

Fax: 330-496-3097 U.S.A. and Canada
330-496-3220 International

U.S.A. MASTER SANITATION DISTRIBUTORS

U.S.A. – North Central (IL, IN, KY, MI, OH)

Midwest Marine Supply
24300 Jefferson Ave.
St. Clair Shores, MI 48080
Tel: 586-778-8950
800-860-1540
Fax: 586-778-6108
E-mail: midwestmarine@yahoo.com
Contact: Bob Kennedy

U.S.A. - Northeast (CT, DE, DC, MA, MD, ME, NH, NJ, NY, PA, RI, VA, VT, WV)

Northeast Marine Sanitation
69 Florida Street
Farmingdale, NY 11735
Tel: 631-752-7606
800-352-4323
Fax: 631-752-7615
888-283-7606
E-mail: northeast@northeast sanitation.com
Contact: Mike Starito

U.S.A. - Northwest (AK, ID, MT, OR, WA, WY)

Marine Sanitation, Inc.
1900 N. Northlake Way, Suite 121
Seattle, WA 98103
Tel: 206-633-1110
800-624-9111
Fax: 206-633-0317
E-mail: marinesan@mindspring.com
Contact: Ric Kolb

U.S.A. - South Central (AR, KS, LA, MO, MS, NM, OK, TX)

AER Supply
P.O. Box 349
2301 Nasa Road #1
Seabrook, TX 77586
Tel: 281-474-3276
800-767-7606
Fax: 281-474-2714
E-mail: rsmiller@aersupply.com
Contact: Richard Miller

U.S.A. - Southeast (AL, FL, GA, NC, PR, SC, TN, VI)

Environmental Marine
111 S.W. 23rd Street, Suite A
Fort Lauderdale, FL 33315
Tel: 954-522-2626
800-522-2656
Fax: 954-522-5152
E-mail: info@environmentalmarine.com
Contact: John or Jill Hopkins

U.S.A. - Southwest (AZ, CO, NV, UT, CA-south)

Ardemco Marine Specialties
778 West 17th Street
Costa Mesa, CA 92627
Tel: 949-722-7672
800-253-0115
Fax: 949-642-9582
E-mail: ardemco@earthlink.net
Contact: Rick Glasser

U.S.A. – Upper Midwest (IA, MN, NE, ND, SD, WI)

PowerHouse Marine
518 Logan
La Crosse, WI 54603
Tel: 608-784-9580
888-752-4539
Fax: 608-784-8422
E-mail: dave@powerhousemarine.com
Contact: Dave Tucker

U.S.A. – Northern California

Fox Marine
2250 Zanker Road, Unit D
San Jose, CA 95131
Tel: 408-451-9055
800-826-2873
E-mail: foxmarco@pacbell.net
Contact: Charlie Barker

CANADA MASTER SANITATION DISTRIBUTORS

Canada - East

Eastern Marine Systems, Inc.
12-A Leslie Street
Toronto, Ontario M4M 3H7
Tel: 416-465-1668
888-764-1111
Fax: 416-465-2098
E-mail: info@eastmar.com
Contact: Paul Gales

Canada - West

Western Marine Company
1494 Powell Street
Vancouver, BC V5L 5B5
Tel: 604-253-7721
800-663-0600
Fax: 604-253-2656
800-663-6790
E-mail: sales@westernmarine.com
Contact: Bill Falk

INTERNATIONAL SEALAND SANITATION SYSTEM DISTRIBUTORS

Call 1-800-321-9886, email us at sealand@dometicus.com, or visit www.dometic.com for the distributor nearest you.

NOTES

NOTES

MANUFACTURER'S THREE-YEAR AND TEN-YEAR LIMITED WARRANTIES

Dometic Corporation warrants, to the original purchaser only, that this Magnum Opus® gravity discharge toilet, if used for personal, family or household-like purposes, is free from defects in material and workmanship for a period of three (3) years from the date of purchase.

Dometic also warrants, to the original purchaser only, that the vitreous china toilet bowl will not discolor, stain, scratch or craze for a period of ten (10) years if used for personal, family or household-like purposes, and is regularly cleaned as described in the product's owner's manual.

If this Dometic product is placed in commercial or business use, it will be warranted, to the original purchaser only, to be free of defects in material and workmanship for a period of ninety (90) days from the date of purchase.

Dometic reserves the right to replace or repair any part of this product that proves, upon inspection by Dometic, to be defective in material or workmanship. All labor and transportation costs or charges incidental to warranty service are to be borne by the purchaser-user.

EXCLUSIONS

IN NO EVENT SHALL **DOMETIC** BE LIABLE FOR INCIDENTAL OR CONSEQUENTIAL DAMAGES, FOR DAMAGES RESULTING FROM IMPROPER INSTALLATION, OR FOR DAMAGES CAUSED BY NEGLIGENCE, ABUSE, ALTERATION, OR USE OF UNAUTHORIZED COMPONENTS. THIS INCLUDES FAILURES WHICH MAY RESULT FROM NOT FOLLOWING THE WINTERIZATION OR CLEANING PROCEDURES AS DESCRIBED IN THIS MANUAL. ALL IMPLIED WARRANTIES, INCLUDING ANY IMPLIED WARRANTY OF MERCHANTABILITY OR FITNESS FOR ANY PARTICULAR PURPOSE, ARE LIMITED TO A PERIOD OF ONE (1) YEAR FROM DATE OF PURCHASE.

IMPLIED WARRANTIES

No person is authorized to change, add to, or create any warranty or obligation other than that set forth herein.

Implied warranties, including those of merchantability and fitness for a particular purpose, are limited to one (1) year from the date of purchase for products used for personal, family or household-like purposes, and ninety (90) days from the date of purchase for products placed in commercial or business use.

OTHER RIGHTS

Some states do not allow limitations on the duration of an implied warranty, and some states do not allow exclusions or limitations regarding incidental or consequential damages; so, the above limitations may not apply to you. This warranty gives you specific legal rights, and you may have other rights which vary from state to state.

To obtain warranty service, first contact your local dealer from whom you purchased this product.



Dometic Corporation • Sanitation Systems
13128 State Rt 226, PO Box 38
Big Prairie, OH 44611
SeaLand Product Customer Service: 1-800-321-9886
(8:00 a.m. - 5:00 p.m. ET)

® Registered; ™ Trademark of Dometic Corporation
® Bar Keepers Friend is a registered trademark of SerVaas Laboratories.
© 2004 Dometic Corporation