



## Integrated Model 700BR Refrigerator Drawers



INTEGRATED



Model 700BR

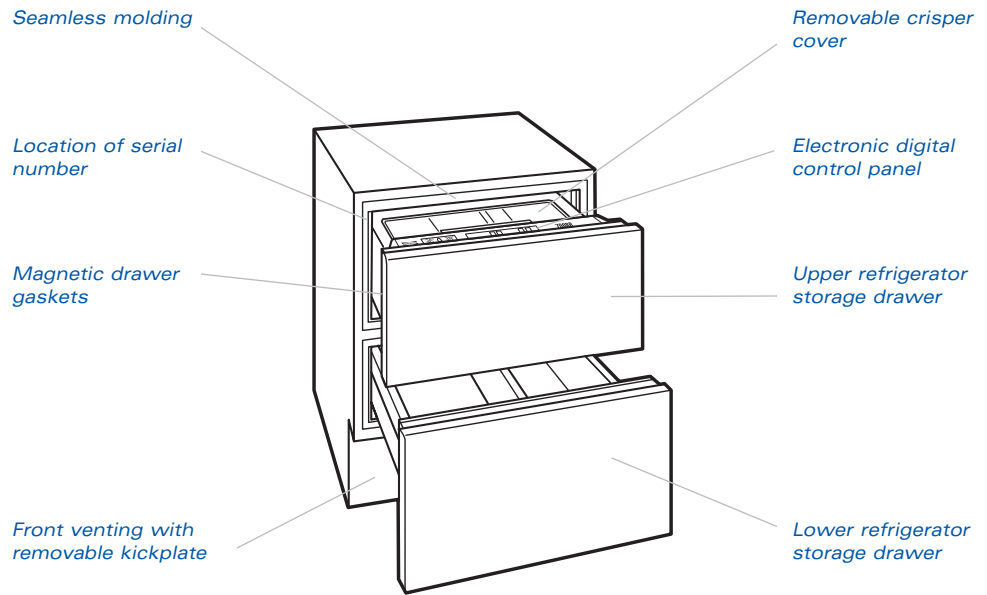

These appliances are Star-K certified from the factory to meet strict religious regulations in conjunction with specific instructions found on [star-k.org](http://star-k.org). No extra wiring harness is required.

► The Sub-Zero Model 700BR integrated design accepts custom wood or stainless steel drawer panels. Stainless steel panels and handles are available as sales accessories in three finishes—classic, platinum and carbon.

One of the more popular models of the Integrated line, this handy two drawer refrigeration system is a must for large and small homes alike. It is a perfect illustration of the concept of a refrigeration system where you can place units where they make the most sense. They can stand alone or work together with other Sub-Zero models to satisfy anyone's needs.

Many homeowners are using them to supplement the main Built-In unit that is installed in the home. With a temperature range of 34°F (1°C) to 45°F (7°C), they are perfect for beverages and vegetables in the island application.



## Integrated Model 700BR

### FEATURES

- ▶ Drawer unit with refrigerator storage drawers
- ▶ Integrated design for "point-of-use" refrigeration anywhere in the home
- ▶ Energy Star qualified
- ▶ Refrigeration system ensures the freshest food and energy efficiency
- ▶ Microprocessor offers precise temperature control ranging from 34°F (1°C) to 45°F (7°C)
- ▶ Electronic digital controls are easily accessed in the top storage drawer
- ▶ Flat to the ceiling bright lighting in storage drawers
- ▶ Alarm will let you know with an audible beeping if a drawer is left open
- ▶ Removable crisper cover with a clear-view window can be used in either storage drawer
- ▶ Each storage drawer has a removable divider
- ▶ Meets strict Department of Energy requirements
- ▶ UL approved for US and Canada
- ▶ Two, five and twelve year residential warranty – exclusions apply; warranty information can be found on our website, [subzero.com](http://subzero.com)

### OVERALL DIMENSIONS

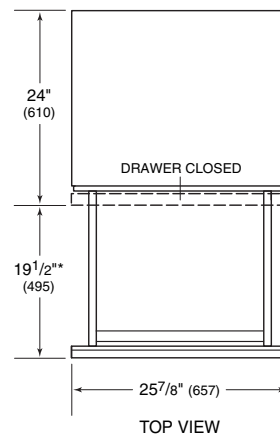
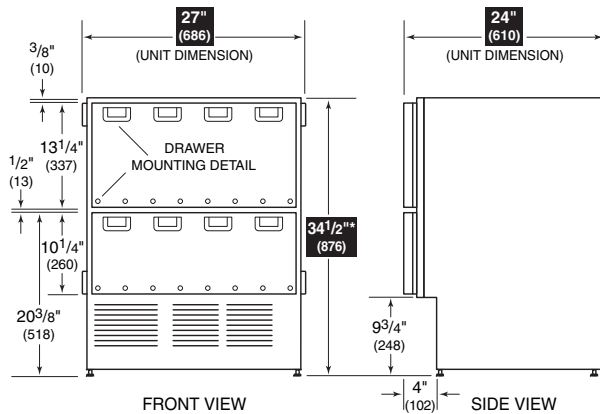

\*DRAWER PANEL THICKNESS NOT INCLUDED



INTEGRATED

Dimensions may vary by ± 1/8" (3).

Dimensions in parentheses are in millimeters unless otherwise specified.



## Integrated Model 700BR



INTEGRATED

### MODEL

Drawer Refrigerator Unit 700BR

### PANEL OPTIONS

Integrated (custom panels)

Classic Stainless Steel Finish /S

Platinum Stainless Steel Finish /P

Carbon Stainless Steel Finish /B

*Stainless steel drawer front panels are ordered and shipped as sales accessories and include tubular handles.*

### ACCESSORIES

- ▶ Drawer front panels with tubular handles in classic, platinum and carbon stainless steel
- ▶ Tubular handles in classic, platinum and carbon stainless steel and polished chrome
- ▶ Dozen egg container with lid
- ▶ Drawer crisper cover with lid
- ▶ Dual installation heater kit

*Accessories are available through your Sub-Zero dealer. To obtain local dealer information, visit the Locator section of our website, [subzero.com](http://subzero.com).*

### SPECIFICATIONS

Model 700BR	Drawer Refrigerator Unit
Overall Width	27" (686)
Overall Height	34 1/2" (876)
Overall Depth	24" (610)
Refrigerator Capacity	5.3 cu ft (150 L)
Minimum Height (levelers in)	34" (864)
Drawer Clearance	19 1/2" (495)
Electrical Requirements	115 V AC, 60 Hz, 15 amp circuit
Annual Energy Usage (based on 9.06 cents per kilowatt hour) Energy Star Qualified	337 kWh / \$31
Shipping Weight	190 lbs (86 kg)
Special Note	Drawer panels and handles are available in three stainless steel finishes

*Specifications are subject to change without notice.*

## Integrated Model 700BR

### INSTALLATION SPECIFICATIONS



INTEGRATED

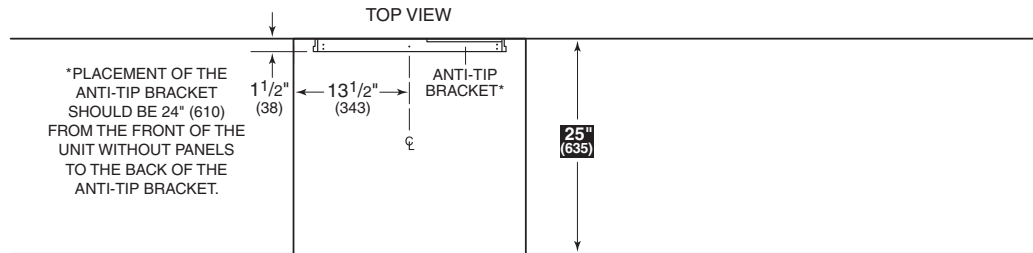

NOTE: ANTI-TIP BRACKET MUST BE INSTALLED TO PREVENT UNIT FROM TIPPING FORWARD

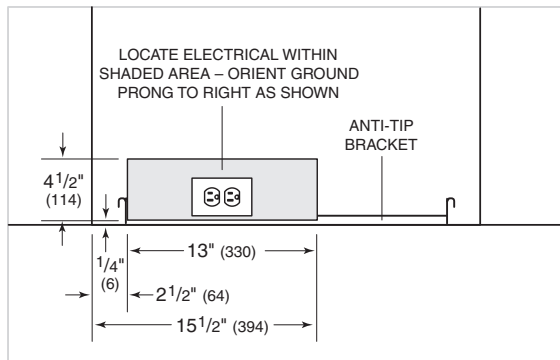
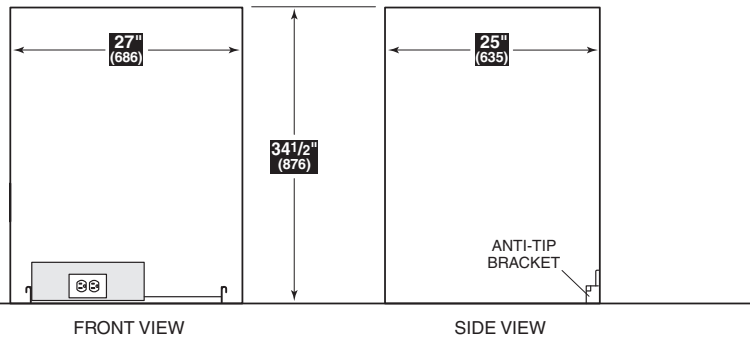

### DIMENSIONS

Finished Rough Opening Width	27" (686)
Finished Rough Opening Height	34 1/2" (876)
Finished Rough Opening Depth	25" (635)*
Location of Electrical	Within shaded area

\*The depth of the Model 700BR is 24" (610) from the front of the unit to its back. Your design may necessitate moving the unit back, or cabinets forward to achieve a flush fit. This will require a minimum rough opening depth of 25" (635).

See Installation Instructions shipped with unit for detailed specifications.



## Integrated Model 700BR

### INSTALLATION NOTES

▶ Refer to the illustrations and specifications for overall dimensions, finished rough opening dimensions and installation specifics.

**IMPORTANT NOTE: The depth of Model 700BR is 24" (610) from the front of the unit to its back. Your design may necessitate moving the unit back, or cabinets forward to achieve a flush fit. This will require a minimum rough opening depth of 25" (635). Refer to the installation illustration on page 4.**

- ▶ The anti-tip bracket must be installed to prevent the unit from tipping forward.
- ▶ Integrated units are compatible with virtually any style of cabinetry. They can be used with framed as well as frameless cabinets.
- ▶ The weight of each drawer panel cannot exceed 12 lbs (5 kg). Drawer panels must be a minimum of  $\frac{5}{8}$ " (16) thick.
- ▶ For the bottom drawer, the maximum panel height is  $16\frac{11}{16}$ " (424). You must keep a minimum space of 4" (102) clear below the bottom edge of the lower drawer panel, so the unit can be properly vented. In addition, any decorative base molding must be removable for possible servicing and cleaning of the condenser.
- ▶ We recommend using D-style handles, which should be located on the top, center area of the drawer panel.

▶ Two Integrated units may be installed next to one another. Refer to page 10 for additional information.

- ▶ A 115 volt, 60Hz, 15 amp circuit breaker and electrical supply are required. A separate circuit, servicing only this appliance is necessary.
- ▶ All Integrated models are equipped with a power supply cord with a 3-prong grounding plug, which must be plugged into a mating 3-prong grounding type wall receptacle. The electrical outlet must be placed so the grounding prong is to the right of the thinner blades. The outlet must be flush with the back wall. Locate electrical within the shaded area shown in the installation illustration on page 4.
- ▶ Do not use an extension cord or two prong adapter. Electrical ground is required on this appliance. Do not under any circumstances remove the power supply cord ground prong.
- ▶ You must follow all National Electrical Code regulations. In addition, be aware of local codes and ordinances when installing your service.
- ▶ The Integrated Refrigeration Installation Instructions packed with the appliance will give you step-by-step procedures for making sure the unit is installed properly.



## Integrated Model 700BR



INTEGRATED

### CABINETRY APPLICATIONS

Integrated refrigeration is compatible with virtually any style and look of cabinetry. The models can be used with framed as well as frameless cabinets. Because of the precise application and the look you may want to achieve, there are important questions you need to answer before ordering panels for the drawers. As you look at styles of cabinets, keep some important facts in mind:

**IMPORTANT NOTE:** The depth of each Integrated unit is 24" (610) from the front of the unit to its back. You **must** allow for the thickness of the panel you are applying when planning for the finished rough opening depth if you want the front panel to be flush with surrounding cabinetry. You may have to move the unit back into drywall or bring the cabinets forward to achieve a flush fit.

**Weight Limitations** - The weight of each drawer panel cannot exceed 12 lbs (5 kg).

**Panel Thickness** - Drawer panels must be a minimum of  $\frac{5}{8}$ " (16) thick.

The toe kick clearance can vary with the height of the lower drawer panel; the maximum panel height is  $16\frac{11}{16}$ " (424). You must keep a minimum space of 4" (102) clear below the bottom edge of the lower drawer panel so the unit can be properly vented.

**IMPORTANT NOTE:** The inside edges of the rough opening, as well as the sides and a portion of the backside of the decorative panels will need to be finished, as they will be exposed when the drawers are open.

We recommend using D-style handles. Locate handles in the top center area of the drawer panels.

## Integrated Model 700BR



INTEGRATED

### FRAMED CABINETRY ▼

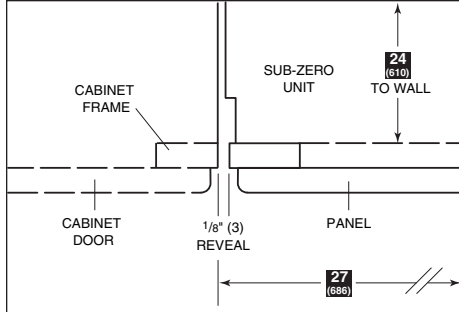

*Traditional Frame – full overlay (top view).*

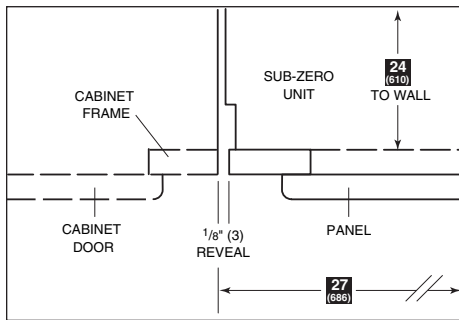

*Traditional Frame – standard overlay (top view).*

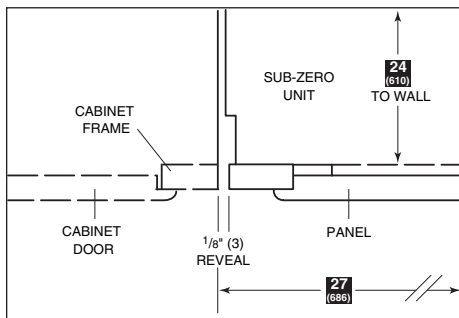

*Traditional Frame – 3/8" (10) offset (top view).*

### FRAMED CABINETRY APPLICATIONS

Framed cabinetry applications present you with different questions to address. The illustrations on this page show common applications of framed cabinetry. These are not meant to be the only alternatives, but are suggestions from designers around the country.

**IMPORTANT NOTE:** The depth of each Integrated unit is 24" (610) from the front of the unit to its back. You **must** allow for the thickness of the panel you are applying when planning for the finished rough opening depth if you want the front panel to be flush with surrounding cabinetry. You may have to move the unit back into drywall or bring the cabinets forward to achieve a flush fit. Refer to the illustrations.

Illustrations on the following pages give dimensions for an Integrated drawer unit installed within a framed cabinetry beaded inset application. Review the illustrations, giving particular attention to the overall panel specifications.

## Integrated Model 700BR

### FRAMED CABINETRY - BEADED INSET APPLICATION

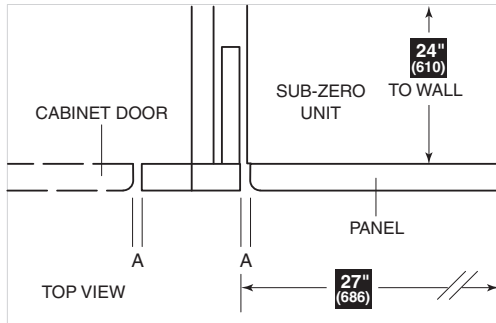

The illustration shows an Integrated drawer unit installed within a framed cabinetry beaded inset application.

**IMPORTANT NOTE:** Dimensions are based on a 1/8" (3) reveal. A reveal of up to 1/4" (6) is possible, but panel dimensions need to be adjusted accordingly.

- A) ALL REVEALS ARE 1/8" (3)
- B) DRAWER RAILS ARE ATTACHED TO DRAWER FRONTS
- C) BOTTOM RAIL MUST BE REMOVABLE

\*DIMENSIONS MAY VARY



INTEGRATED

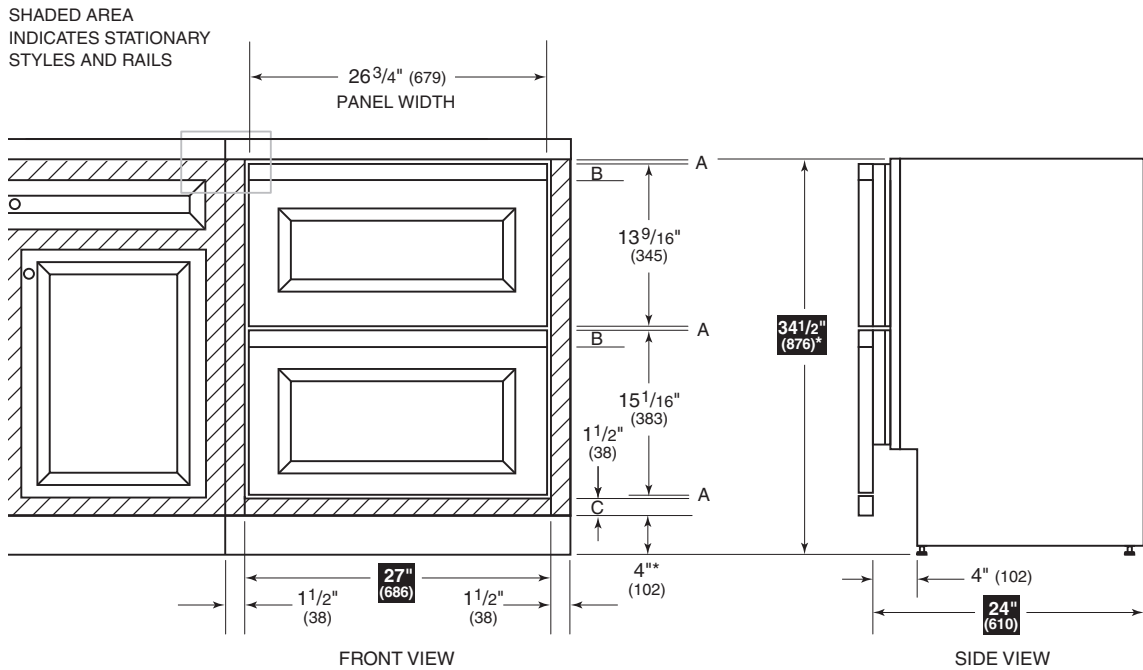

*Installation of an Integrated drawer unit within framed cabinetry.*

*\*Dimensions may vary.*

*Dimensions in parentheses are in millimeters unless otherwise specified.*



## Integrated Model 700BR



INTEGRATED

### FRAMELESS CABINETRY APPLICATIONS

The illustration below shows a hypothetical installation of an Integrated drawer unit within frameless cabinetry. Review the illustration, giving particular attention to the overall panel specifications.

**IMPORTANT NOTE:** Dimensions are based on a 1/8" (3) reveal. A reveal of up to 1/4" (6) is possible, but panel dimensions need to be adjusted accordingly.

### FRAMELESS CABINETRY ▼

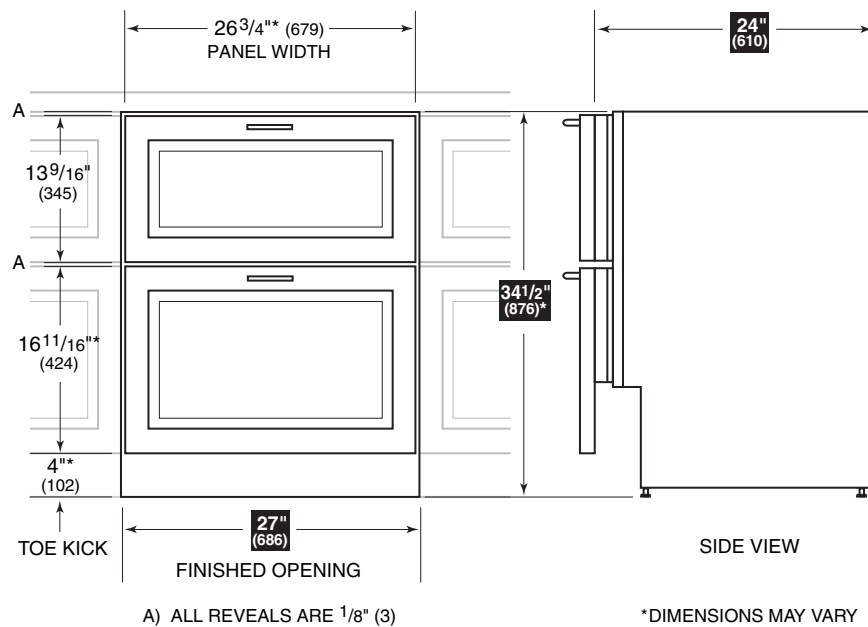

*Installation of an Integrated drawer unit within frameless cabinetry.*

*\*Dimensions may vary.*

*Dimensions in parentheses are in millimeters unless otherwise specified.*

## Integrated Model 700BR



INTEGRATED

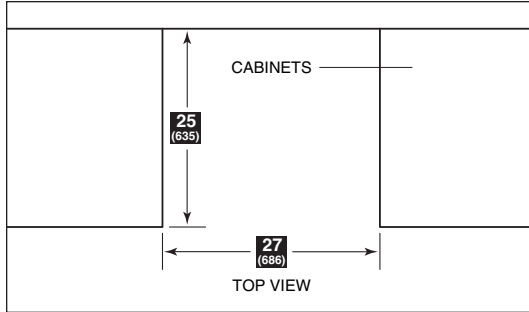

*Installation without side panels.*

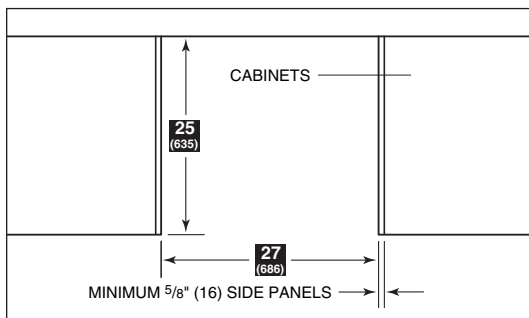

*Installation with side panels.*

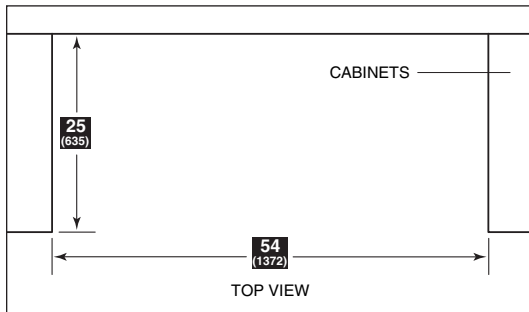

*Installation of two units side by side.*

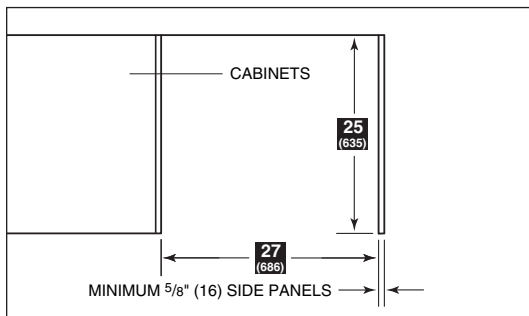

*Installation at end of run.*

### INSTALLATION OPTIONS

The illustrations on this page show some typical installations and their dimension considerations. The depth dimension in the illustrations may vary depending on cabinet styles, treatment of countertops or other design options.

**IMPORTANT NOTE:** The depth of each Integrated model is 24" (610) from the front of the unit to its back. Your design may necessitate moving the unit back, or cabinets forward to achieve a flush fit. This will require a minimum rough opening depth of 25" (635). Refer to the illustrations.

### DUAL INSTALLATIONS

If two or more Integrated models are installed side by side where there is 2" (51) or less of space between the units, a heater kit is recommended—BBDUAL for two drawer units installed side by side or a drawer unit and a tall unit installed side by side. This optional component is available through your Sub-Zero dealer. To obtain local dealer information, visit the Locator section of our website, [subzero.com](http://subzero.com).

## Integrated Model 700BR



INTEGRATED

### TOE KICK CLEARANCE

The toe kick clearance can vary with the height of the lower drawer panel; the maximum panel height is  $16\frac{11}{16}$ " (424).

**IMPORTANT NOTE:** You must keep a minimum space of 4" (102) clear below the bottom edge of the lower drawer panel so the unit can be properly vented. In addition, any decorative base molding must be removable for possible servicing and cleaning of the condenser.

The illustration below shows the area below the lower drawer where the operating mechanical equipment of the Integrated unit is housed.

**IMPORTANT NOTE:** The depth of each Integrated unit is 24" (610) from the front of the unit to its back. Your design may necessitate moving the unit back, or cabinets forward to achieve a flush fit. This will require a minimum rough opening depth of 25" (635). Refer to the illustration.

### TOE KICK AREA DETAIL ▼

