



General Mobile Radio Service (GMRS)

Model: GMRS-3000PK

Rechargeable GMRS Handset Transceiver and
Base Station Transceiver With NOAA Weather
Alert

Owner's Manual

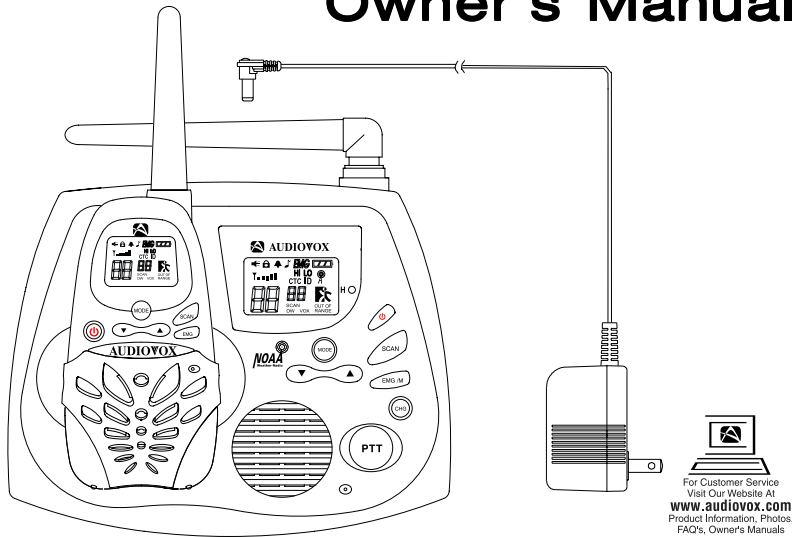

© 2002 Audiovox Electronics Corp., Hauppauge, NY 11788

Customer Service
1-800-290-6650

Released: 9-6-02.

128-6476
1 of 28

For Customer Service
Visit Our Website At
www.audiovox.com
Product Information, Photos,
FAQ's, Owner's Manuals

 **CAUTION**

NEVER ATTEMPT TO CHARGE ALKALINE OR DRY CELL BATTERIES, AS BATTERIES MAY BURST CAUSING PERSONAL INJURY AND DAMAGE TO THE PRODUCT. WHEN RECHARGING NICKEL METAL HYDRIDE (NiMH) BATTERIES WITH THE SUPPLIED AUDIOVOX CHARGER AND WALL ADAPTER, USE ONLY AUDIOVOX-APPROVED RECHARGEABLE BATTERIES. USE OF THE AUDIOVOX CHARGER WITH OTHER BRANDS OF BATTERIES IS NOT RECOMMENDED, AS BATTERY CHARGING TIMES WILL VARY WITH DIFFERENT BRANDS. REFER TO THE MANUFACTURER'S INSTRUCTIONS FOR CHARGING OTHER BRANDS OF BATTERIES.

AVOID PLACING THE GMRS-3000PK RADIO TRANSCEIVER FOR PROLONGED PERIODS OF TIME IN DIRECT SUNLIGHT OR TEMPERATURES BELOW -4° F (-20° C) OR ABOVE 140° F (60° C).

KEEP THE ANTENNA AT 1 INCH (2.5 cm) AWAY FROM YOUR HEAD AND BODY. DO NOT USE YOUR GMRS-3000PK RADIO TRANSCEIVER WITH A DAMAGED ANTENNA.

PLACE THE RUBBER COVERS ON JACKS WHEN NOT IN USE.

GMRS LICENSE:

USE OF THIS RADIO WITHIN THE UNITED STATES REQUIRES AN FCC GMRS LICENSE. AN INDIVIDUAL 18 YEARS OF AGE OR OLDER, WHO IS NOT A REPRESENTATIVE OF A FOREIGN GOVERNMENT, IS ELIGIBLE TO APPLY FOR A GMRS SYSTEM LICENSE. YOU WILL NEED TWO FORMS FROM THE FCC; FCC FORM 159 AND FCC FORM 605 MAIN FORM AND SCHEDULE F. YOU CAN FIND THE FORMS ONLINE AT: [HTTP://WWW.FCC.GOV/FORMPAGE.HTML](http://www.fcc.gov/formpage.html), OR CALL 1-800-418-3676.

COMPLIANCE:

This transceiver complies with FCC regulations for use in the United States of America. Use in other countries may be prohibited or restricted by local regulation. Please check with the local regulating agency before using this device outside the United States of America.

GMRS-3000PK Handset and Base Station Transceivers

The handset transceiver, when equipped with NiMH rechargable batteries, can be recharged when placed in the fixed base station transceiver cradle, which also acts as a desk-top charger.

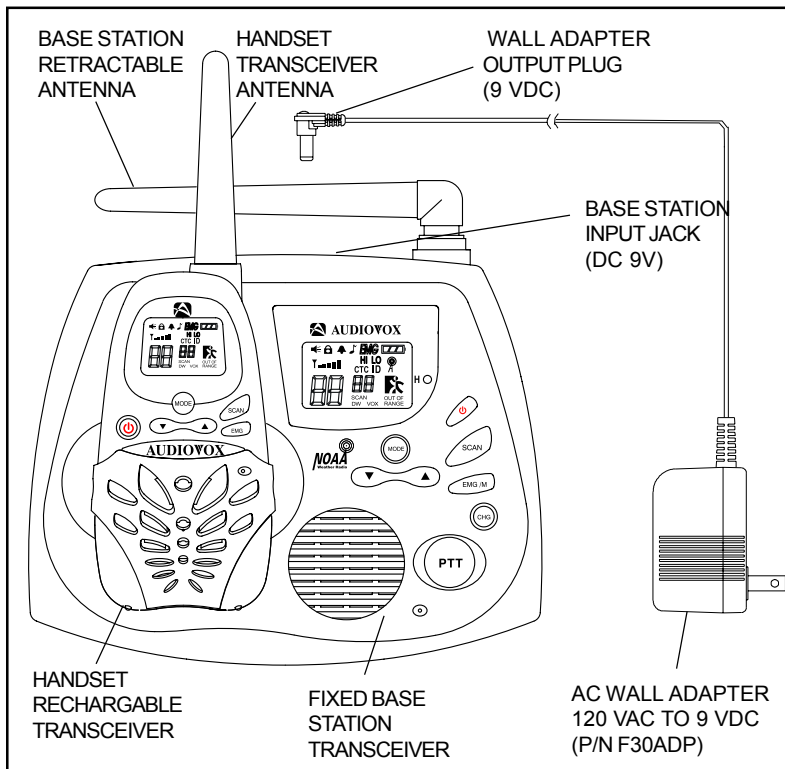

GMRS-3000PK Handset Controls and Indicators

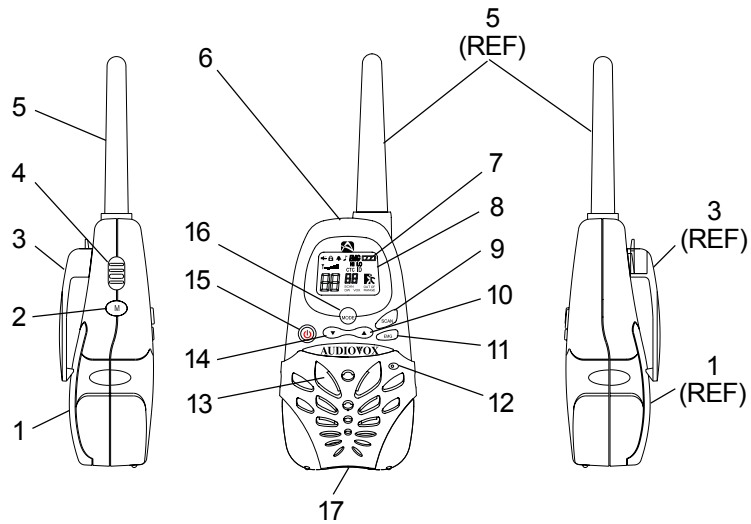

- | | |
|---|---------------------------------|
| 1. Battery Door | 9. SCAN/Lock Button |
| 2. Monitor/Backlight Button | 10. Up Channel/Volume Button |
| 3. Detachable Carry Clip | 11. Emergency (EMG) Call Button |
| 4. Push-To-Talk (PTT) Button | 12. Built-in Microphone |
| 5. Antenna | 13. Built-in Speaker |
| 6. External Speaker(SPK)/Microphone (MIC) Jacks | 14. Down Channel/Volume Button |
| 7. Liquid Crystal Display (LCD) | 15. Power On/Off Control |
| 8. Combination Transmit Indicator (Red)/Receive and Monitor Indicator (Green) | 16. MODE Button |
| | 17. Battery Charging Contacts |

GMRS-3000PK Base Unit Controls and Indicators

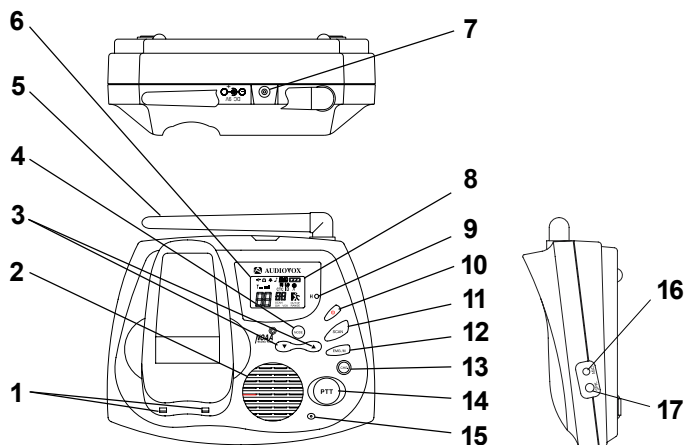

- | | |
|--|--|
| 1. Handset Battery Charge Contacts | 9. Battery Charge LED (Red) |
| 2. Built-in Speaker | 10. Power On/Off and Function Set Button |
| 3. Up/Down Channel/Volume Buttons | 11. SCAN/Lock Button |
| 4. MODE Button | 12. Emergency (EMG) and Monitor (M)/Backlight Button |
| 5. Antenna | 13. Handset Battery CHG Button |
| 6. Combination Transmit Indicator (Red)/Receive and Monitor Indicator (Green)/Backlighting (Red/Green) | 14. Push-To-Talk (PTT) Button |
| 7. DC 9V Charger Input Jack | 15. Built-in Microphone |
| 8. Liquid Crystal Display (LCD) | 16. External Microphone (MIC) Jack |
| | 17. External Headset/Speaker (SPK) Jack |

GMRS-3000PK Handset and Base Station Displays

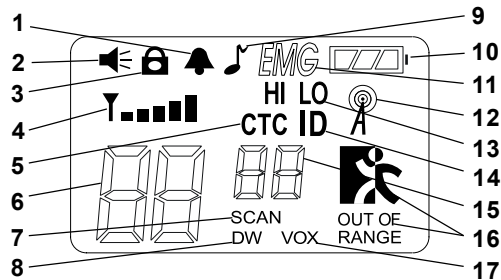

- 1. Beep Tone Indicator:** Icon appears when beep confirmation tone is selected; icon disappears when tone is off.
- 2. Monitor Indicator:** Icon appears when the Monitor (**M**) button is pressed and the channel monitor function is activated.
- 3. Key Lock Indicator:** Icon appears when the keypad is locked. This function disables keys such as channel up/down and MODE.
- 4. Signal Strength Indicator:** Icon appears when a signal is being received. The icon consists of five bars to indicate the received signal level.
- 5. Continuous Tone Coded Squelch System (CTCSS) Indicator:** Indicator appears when the CTCSS tone function is active.
- 6. Large Segment Display:** Indicates the GMRS/FRS channel number in use.
- 7. Scan Indicator:** This indicator appears when the scan function is active to scan a channel every 0.5 second.
- 8. Dual Watch Mode Indicator:** Indicator appears when dual watch mode is active.
- 9. RogerBeep Tone On/Off Indicator:** This icon appears when the Roger Beep tone is on, and disappears when tone is not in use.

- 10. Battery Level Indicator:** Icon indicates the battery charge level.
- 11. Emergency (EMG) Indicator:** **EMG** icon appears when the EMG/M button pressed. (The emergency frequency is not monitored by authorities.)
- 12. Weather Mode Indicator (Base Station Only):** This icon appears steady on the Base Station display when the weather mode is active; it flashes when weather alert is active in the GMRS mode.
- 13. Power HI/LO Indicators:** Appropriate icon appears when the transmit power is set to desired output power on the GMRS channels only.
- 14. Caller Identification (ID) Indicator:** This indication appears when you select a caller identification code (between 1 and 10). ID selection operates in conjunction with the small segment display, and can also be used to identify a calling party in the monitor mode.
- 15. Small Segment Display:** Displays the CTCSS tone option in the channel from (01-38).
- 16. Out of Range Indicator:** Icon flashes when signal strength becomes weak and intermittent.
- 17. Voice Activated Transmission (VOX) Indicator:** The indicator appears when the VOX mode is activated.

Powering the Transceivers:

Your GMRS-3000PK handset transceiver operates on four AAA batteries. Alkaline batteries will provide slightly better performance than the supplied rechargeable batteries. Only Audiovox approved rechargeable batteries can be recharged in the handset transceiver using the Base Station charging feature and the Wall Charging Adapter supplied with the unit. This will ensure optimum performance for the GMRS-3000PK. Use of the Base Unit charging feature with other brands of batteries is not recommended as battery charging times will vary. Refer to the manufacturer's instructions for charging other brands of batteries.

Equipment and Accessories Supplied

- | | |
|---------------------------|--|
| 1. Radio Transceivers (2) | GMRS-3000PK (Handset and Fixed Base Station) |
| 2. Owner's Manual (1) | 128-6476 |
| 3. Batteries (4) | Rechargeable NiMH (P/N F30BATT) |
| 4. AC Wall Adapter | (P/N F30ADP) |

Batteries

There are three methods of powering the GMRS-3000PK Handset Transceiver:

1. Alkaline Batteries.

WARNING: Do not attempt to recharge Alkaline batteries. Also, make sure to turn off the charger feature of the base station when rechargeable batteries are not being used.

2. Audiovox Rechargeable NiMH Batteries - (Rechargeable NiMH batteries, Base Station Transceiver, and Wall Charging Adapter included as part of the GMRS-3000PK). Use only Audiovox approved rechargeable batteries and Base Station charger when charging batteries internal to the Handset Transceiver.

3. Various Brands of Rechargeable Batteries - Use of the Base Station charging feature with other brands of rechargeable batteries is not recommended, as battery charging times will vary with different brands of batteries. Refer to the manufacturer's instructions for charging other brands of batteries.

The battery charge indicator icon displays the battery charge level in the handset transceiver. When the AC adapter is connected to the base station transceiver, its indicator icon will always indicate a full charge when the base station is powered on. A full charge of batteries in the handset transceiver is indicated by the battery icon as shown below:



Full Battery - three segments are illuminated.

Low Battery - one segment is illuminated.

Approximately 10-12 hours are required to fully charge the batteries in the handset transceiver. The red **H** LED charging indicator (9) on the base station transceiver will light whenever the batteries are charging. If the charging indicator flashes on/off momentarily when the CHG button is pressed to on, it is likely no batteries are installed in the handset unit. You must set the CHG button off when using any batteries other than the ones provided for the handset transceiver. Failure to do this may cause damage to the batteries resulting in personal injury and/or damage to either, or both, transceivers.

Caution: The charging adapter is intended for use with the supplied rechargeable NiMH batteries, Part Number F30BATT. Do not attempt to recharge any other type batteries.

Installing the Batteries in the Mobile Transceiver

Battery installation in the Mobile Transceiver is made more convenient when the carry clip is removed. To do this, release the spring latch securing the clip to radio and slide the clip downward and away from the radio body.

Next, press down with the thumb at the embossed arrow on the battery compartment cover, and slide the battery cover down and off the radio. Insert four AAA batteries (alternate positive ends (+) toward the bottom of the transceiver, (starting left-to-right).

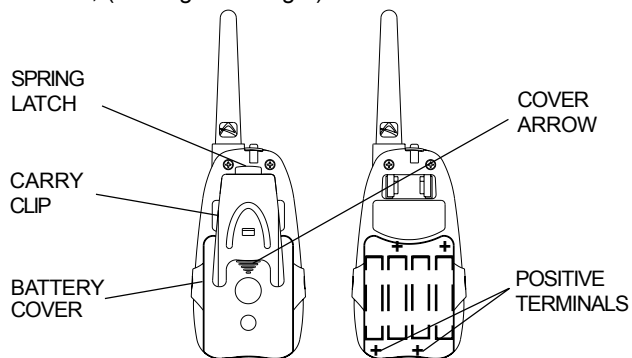

1. Using thumb, press down on battery cover at arrow and slide cover down.
2. Then lift up cover at bottom to open. Then remove cover from unit.
3. Insert four AAA batteries (positive (+) end toward the bottom beginning at left side and alternating positive terminals as shown).

The following guidelines will improve performance and provide longer operating times for the GMR-3000PK handset transceiver:

1. Do not mix old and new batteries.
2. The use of alkaline-type batteries is recommended to provide the longest operating time.
3. Do not mix alkaline, standard (carbon-zinc) or rechargeable batteries.
4. If the unit is not to be used for an extended period of time, remove the batteries. Old or leaking batteries can cause damage to the unit and will void the warranty.

Base Station Transceiver Charging Setup For the Handset Transceiver

When the handset transceiver is equipped with rechargeable NiMH batteries (supplied), they may be charged using the base station setup as follows:

1. Position the handset transceiver in the base station cradle as shown.
2. Connect the charging adapter plug to the DC 9V jack at the rear of the base station transceiver.
3. Plug the other end of the charging adapter into a 120 VAC outlet.
4. Apply power to the base station; then momentarily press the CHG button. The **H** indicator lights **red** indicating the handset transceiver batteries are being charged.
5. To terminate battery charge, remove the handset from the cradle or momentarily press the CHG button again; the **H** indicator will extinguish.

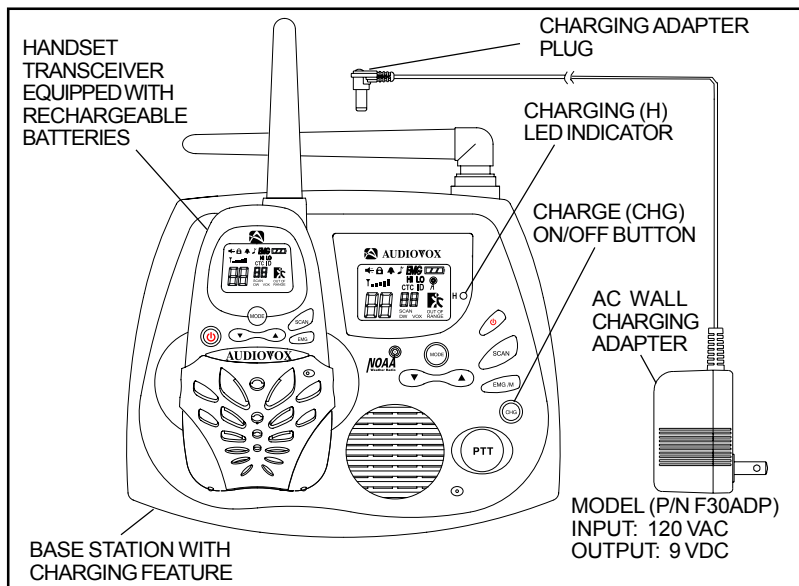

GMRS-3000PK OPERATIONAL MODES

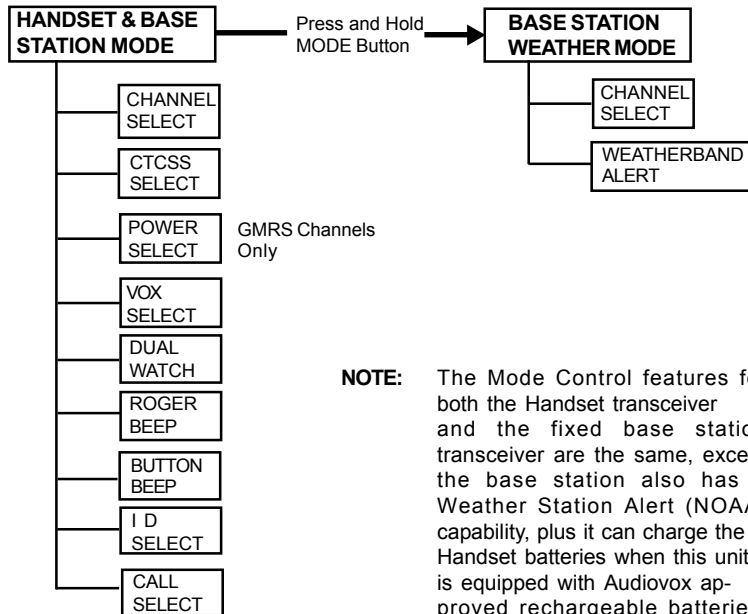

NOTE: The Mode Control features for both the Handset transceiver and the fixed base station transceiver are the same, except the base station also has a Weather Station Alert (NOAA) capability, plus it can charge the Handset batteries when this unit is equipped with Audiovox approved rechargeable batteries.

Controls:

Power On/Off Button



Press and hold the power on/off button () for at least 2 seconds. You will hear a confirming melody to indicate the unit is on. To turn the unit off, press and hold the button for at least 2 seconds.

Adjusting the Volume

With either transceiver powered on, press the respective Up Channel/Volume button () to increase volume and the Down

Channel/Volume button (▼) to decrease volume. The display will indicate the current volume level between 1 and 7 by the small number in the icon (U ⁰⁵).

Monitor/Display Backlight Button

This button is used to check activity on the current frequency before transmitting. Check activity by pressing the Monitor (M) Button longer than 2 seconds; the  icon will appear on the display and you will hear static if frequency is clear. **Do not transmit if you hear conversation.** Hold down the Monitor Button again longer than 2 seconds and the  icon will disappear from the display.

The monitor function will temporarily bypass the squelch setting and play all signals on a given channel. This feature is useful when communicating with other parties at extreme range.

By pressing the monitor button momentarily, the green monitor LED (left side) and red LCD backlight (right side) are both turned on accompanied by a beep tone; both LEDs will turn off automatically in about 5 seconds, or when the monitor button is pressed momentarily once again.

Push To Talk (PTT) Button

Pressing and holding this button will allow you to speak to any transceiver that is set to the same channel and privacy code setting as yours. Hold the transceiver approximately 1 to 2 inches from your face as you speak into the built in microphone . After you have finished speaking, release the PTT Button to allow reception of incoming signals. It is not possible to transmit and receive at the same time. The Transmit/Monitor LED at the upper inside right corner of the LCD Panel will light **red** while the PTT Button is pressed.

Releasing the button allows the unit to revert to standby mode. When receiving an incoming signal, the Transmit/Monitor indicator at the upper inside left corner of the LCD panel will light **green**, and the received signal strength indicator () will display the relative strength of the signal. The PTT Button can also be used as a two-way call ringer. Pressing the button twice quickly will call another party on the same channel. The call ring melody will sound on the receiving unit for approximately 3 seconds.

Up Channel/Volume Button

In the standby mode, pressing this button will increment the listening volume. When in function edit mode this button will be used to adjust the unit's settings.

Down Channel/Volume Button

In the standby mode, pressing this button will decrement the listening volume. When in function edit mode this button will be used to adjust the unit's settings.

Mode Button

This button is used to select the various feature settings such as channel/ CTCSS code selection, VOX mode, etc.

External Speaker (SPK)/Microphone (MIC) Jacks

These jacks, one on the handset (6), and two on the base station (16,17) accept an external Audiovox headset/microphone connector (optional accessory). For additional optional equipment and accessories for the GMRS-3000PK, visit the Audiovox web site at www.audiovox.com.

Scan/Lock Button

Press this Button momentarily to enable or disable the scan mode. Press and hold the button for more than 1 second to lock or unlock the key pad. All buttons will be active in the lock mode except, MODE and SCAN. When the keypad is locked, the () icon will display in the top left corner.

Operating Modes and Features

GMRS/FRS Operation:

- From the GMRS/FRS standby mode, press and hold the () button for 2 seconds to turn on power.
- Press the MODE button so the Channel number flashes.
- Select the desired channel with the Up and Down Buttons. When receiving a call, the Monitor LED lights **green**, and the signal strength meter, consisting of a 5-bar graph, is displayed and indicates incoming received signal strength from minimum (a single bar) to maximum (five bars).

- Press and hold the PTT button to transmit, then speak into the microphone clearly and slowly. The Transmit LED lights **red**.
- Release the PTT Button to receive.
- Communication can only be accomplished when the channel and CTCSS tone frequency of at least two parties are the same.
- The **CTC** icon will be displayed on the LCD panel if the CTCSS tone frequency function is enabled.

Channel Selection

In order to communicate with other FRS units, both transmitting and receiving party must be on the same frequency.

The GMRS-3000PK has 22 channels (frequencies) indicated by the large digits on the LCD display panel. Channels 1-7 are shared GMRS/FRS channels; channels 8-14 are FRS only channels, while channels 15-22 are assigned GMRS only channels. If an FRS only channel (8-14) has been selected, the HI or LO icon will not be displayed on the LCD panel; otherwise, for channels 1-7 (GMRS/FRS) and 15-22 (GMRS only), the **HI** or **LO** icon will be displayed. Communication with Audiovox GMRS/FRS and compatible units is possible on these 22 channels. Before transmitting on the selected channel, press the Monitor (M) Button to check the activity on that channel. If there is activity on the selected channel, change to another channel that is clear.

To change the channel:

- From GMRS/FRS standby mode, press the MODE button once, or until the channel number flashes.
- Press the Up Button briefly to move to the next higher main channel number.
- Press the Down Button briefly to move to the next lower main channel number.

CTCSS Mode (Sub-Channel) Selection

The Coded Tone Controlled Squelch System (CTCSS) provides 38 Sub-Frequencies. This feature allows you to utilize the coded squelch tones (01–38) within a main channel and enables you to communicate with

another party on the same main channel using the same subcode. (This filters out unwanted transmissions without the same coded squelch tone). There are 38 CTCSS Sub-channels for each main channel. A different subcode may be selected for each of the 14 channels.

To change the CTCSS Sub-channel:

- From GMRS/FRS standby mode, press the MODE Button twice; a flashing **oF** or sub-channel number is displayed, together with the flashing **CTC** icon. If **oF** is displayed, press the Up or Down button to enable the CTCSS mode; the **CTC** icon will also flash on the display with the flashing sub-channel number.
- Then press the Up or Down button to select the desired sub-channel for use.
- Press the PTT button momentarily to confirm selection.

The CTCSS mode can be turned off by selecting the **oF** icon as the setting.

NOTE: To communicate with other FRS units, they must be switched to the same channel and CTCSS subcode. To communicate with other FRS units that do not have subcodes, switch your unit to the same channel with the subcode set to **oF**.

The CTCSS subcodes do not prevent others from hearing your transmission. This will only allow you to ignore all traffic on a given channel not using the same subcode.

Transmit Power Selection Mode

This feature permits selection of the transmitting power level to high or low on the GMRS channels. (**FRS only channels 8-14 automatically operate on low power only.**) Using low power, the unit will have a lower transmit range, but battery life will be increased.

NOTE: You will find that for the majority of your needs, the low-power setting will provide adequate communications on all channels; there should seldom be any need to use high power, except in situations where you need absolute maximum range. Using low power will greatly extend battery life. We suggest you experiment with switching between low and high power. However,

we do recommend that you **not change** this setting unless it proves to be necessary in your particular situation.

To access the transmitter power selection function, the selected channel must be either GMRS/FRS (1-7) or GMRS only (15-22). Select the desired power as follows:

- From GMRS/FRS standby mode, press the MODE Button 3 times until the **Po HI** or **Lo** indication appears with a flashing **HI** or **LO** indication on the display.

NOTE: If the current channel is FRS only (8-14), **power will not be selectable.**

- Press the Up or Down button to toggle between the High and Low selections.
- Press the PTT button momentarily to confirm selection.

VOX Selection Mode

This option enables you to have hands-free conversation. Your voice or nearby sound is detected and the radio transmits without the need to press the PTT button.

To set radio for VOX operation:

- From GMRS/FRS standby mode, press the MODE button 4 times until **Uo** appears with the **VOX** icon flashing on the display.
- Press the Up or Down button to select VOX On (if **oF** appears flashing) and the **1-5** VOX level sensitivity.
- Momentarily press the PTT button to confirm the VOX selection.
- The **VOX** icon will appear steady on the LCD display.

A VOX sensitivity of **1** is the most sensitive, and should be used in a relatively quiet surrounding. A VOX sensitivity of **5** is the least sensitive and should be used in a noisy surrounding.

VOX can be turned off by selecting **oF** as the setting.

Dual Watch Mode

This feature allows you to monitor two channels at the same time. While in dual watch mode, the unit will continuously monitor both the primary and dual watch channel. Received signals will be played for 5 seconds, then

the unit will resume scanning the two channels. Pressing the PTT button during a received transmission will set the unit to transmit on the same channel. Pressing the PTT button when no signal is received will set the unit to transmit on the primary channel.



To set the Dual Watch Mode:

- From GMRS/FRS standby mode, press the MODE button 5 times; **dc** appears on the display with the flashing **DW** icon. If the dual watch mode is off, the **oF** icon will also appear flashing.
- To enable the dual watch mode, press the Up or Down button; the dual watch channel number will flash and start to increment up or down as the Up or Down button is pressed.
- Press the PTT button to confirm selection of the dual watch channel. The display will now alternate between the primary channel and the dual watch channel just selected.

Roger Beep Tone

The Roger Beep is a tone which is automatically transmitted whenever the PTT button is released. This tone alerts the receiving party that the transmission has been terminated intentionally.

To enable and disable the Roger Beep tone:

- From GMRS/FRS standby mode, press the MODE Button 6 times until **rb** appears on the display with the flashing Roger Beep icon () and **On** or **oF**.
- Press the Up or Down Button to select the tone on or off as desired.
- When enabled, the tone icon () appears steady on the display.
- Press the PTT button momentarily to confirm selection.

Key Tone

This feature allows the transceiver to sound a confirmation tone whenever the following keys are pressed: Monitor (M) Button, Up/Down Buttons, MODE Button or the SCAN Button.

To turn the key tones on or off:

- From GMRS/FRS standby mode, press the MODE Button 7 times until **bP**, the Bell () icon, and **On** or **oF** flash on the LCD display.

- Press the Up or Down Button to toggle the key tone feature On or Off.
- Press the PTT button momentarily to confirm selection.

When the key tone feature is on, the Bell icon appears steady on the display, and the beep tones sound in response to button activation.

Caller Identification (ID) Select

The caller ID function allows you to assign an ID code between 1 and 10; this code accompanies your transmission whenever you call another party, and will appear at the receiving unit, provided it has caller ID capability.

To select a caller ID code for your unit:

- From GMRS/FRS standby mode, press the MODE button 8 times; **Id** appears, together with a flashing **ID** and number (or **oF**) indication.
- If **oF** appears, press the Up or Down Button to select the desired caller identification code for your unit between 1 and 10.
- Press the PTT button momentarily to confirm selection.

Now, your caller ID number will accompany each call transmission, and will appear on the receiving unit, if so equipped, and vice-versa.

Call Ringer Selection Mode

The transceiver provides 3 user-selectable call ringer melodies to alert you to an incoming call.

To select your call ringer melody:

- From GMRS/FRS standby mode, press the MODE button 9 times; **C** will appear on the display, together with a flashing number (or **oF**) between **01** and **03**, and an appropriate call ring.
- Press the Up or Down Button to preview and hear the 3 available call melodies.
- Press the PTT button momentarily to confirm selection.

Refer to the PTT button (4) to transmit ring signal.

Channel Scan Operation

This feature allows you to monitor all channels automatically for activity. While scanning, you can transmit and receive. When a signal is received,

the scan is interrupted and will return to scan mode 5 seconds after reception is terminated.

NOTE: While the scan function is active, the MODE button will be inoperative. The scan mode will reduce the overall battery life since the battery save function is overridden.

To enable the channel scan mode:

- From GMRS/FRS standby mode, momentarily press the SCAN Button; (**SCAN**) will appear on the LCD display.
- The radio will display each channel (1-22) in order as the scan mode operates to find an active main channel.
- If the unit doesn't find any signals and you want to transmit, press the PTT switch to return to home channel operation. The transceiver will automatically resume scanning approximately 5 seconds after the communication is completed.
- If there is no activity and you want to leave the scan mode, press the SCAN button momentarily and the unit will return to normal operation; **SCAN** icon will disappear from the LCD display.

Emergency and Assistance Channel Mode

This radio has a quick access button (EMG/M) to the Emergency and Assistance Channel. This channel is not monitored by local authorities. When using this channel, **EMG** appears on the display. Pressing this button will set the transceiver to the channel 20, 462.6750 MHz).

The Emergency Channel can be selected quickly from any user mode.



To access the Emergency Channel mode:

- Press Emergency (EMG) Button; **EMG** and Channel **20** appears on the display.
- To turn off the Emergency Channel feature, press and release the EMG Button.

Auto Key Lock Selection Mode

This feature prevents accidental or unintentional change to the preferred settings of the unit. The Auto Key Lock function temporarily disables the MODE and SCAN Buttons.

To access the Auto Key Lock selection menu:

- From GMRS/FRS standby mode, press and hold the Scan Button for over 2 seconds to Lock the Auto Key function; the () icon appears on the display.
- The Power, PTT, Up/Down and Monitor Buttons are not effected.
- To unlock the Auto Key function, press and hold the SCAN button for at least 2 seconds; the icon () disappears from the display.

NOTE: If the unit is turned off while Key Lock is on, the Key Lock mode will still be in effect when the unit is turned on again.

Out of Range Indication

The GMRS-3000PK provides an Out-of-Range indication when reception is no longer intelligible or too weak to be discernible. When this condition occurs, the **OUT OF RANGE** message and  icon appears intermittently (or steadily) on the display, reminding you that you are outside the reception range of the transmission, or that signal reception is being obstructed by native or man-made objects.

Base Station Weather Band Operation

Weather Channel Selection

The weather channel selection feature of the Base Station Transceiver provides access to 10 channels within the weather band (7 NOAA channels and 3 Canadian marine channels). To enter the radio weather channel mode, proceed as follows:

- From the GMRS/FRS standby mode, press and hold the MODE button for at least 2 seconds; a melody will sound and the unit will enter the weather standby mode. The NOAA weather icon () will appear on the display accompanied by background noise.
- From the Weather band standby mode, press the MODE button once so the channel number flashes.
- Press the Up button briefly to move to the next higher weather channel number.
- Press the Down button briefly to move to the next lower weather channel number.

- Momentarily press the PTT or Power button to confirm weather channel selection.

To exit the Weather standby mode, press and hold the MODE button for at least 2 seconds; the weather alert icon disappears.

Weather Alert Mode



When the unit is in the weather standby mode and the weather alert is active, when a weather alert signal is received, the unit will generate a warning tone. The unit will then revert to the previously selected weather channel for monitoring purposes.

To access the weather alert function:

- From Weather Band standby mode, press the MODE button twice to access the weather alert function; the weather alert icon () and **AL On** or **oF** appear flashing on the display.
- Press the Up or Down button briefly to select weather alert **On** or **oF** as desired.

NOTE: When **On** is selected, and the PTT button is pressed to confirm the weather alert mode, the alert icon will blink on and off at 5-second intervals, indicating the weather alert mode is active and is monitoring one of 10 weather channels.

Handset Transceiver Battery Alert

When the battery icon () blinks on the LCD panel, recharge unit or install fresh batteries. If the batteries are not replaced the () icon will appear and an audio tone will sound to warn the user that the batteries must be replaced.

NOTES FOR GOOD COMMUNICATION

1. The GMRS-3000PK 22 channels are shared on a 'take turns' basis. This means other groups may be talking on any of the channels. A common code of ethics/courtesy is to switch to another vacant channel and not to attempt to talk over someone who is already using the channel you first selected.

128-6476
22 of 28

2. The FRS-3000PK has been designed to maximize performance and improve transmission range in the field. To avoid interference, it is recommended that you do not use the units closer than 5 feet apart.
3. For best transmission results, always keep your mouth about 2-3 inches from the microphone (12, *15) and speak slowly in a normal voice.
4. To increase battery life in the hand-held transceiver, avoid features such as Scan and Dual Watch. These features will reduce operating time considerably.

Warning

- Remove the batteries from the hand-held transceiver if it is not expected to be used for long periods. This will eliminate the possibility of chemicals leaking from the batteries and corroding the transceiver.
- Avoid exposing the transceivers to water or extremes of temperature.
- Do not use these devices in or near a mining facility, which uses remotely triggered explosives or in areas labeled "Blasting Area". Premature or accidental detonation may result.
- Do not attempt to modify or in any way increase the output of these transceivers. The outputs are designed to meet the legal limits set by the FCC.
- Do not use these devices or change the batteries in potentially explosive atmospheres as sparks in such areas could result in an explosion.
- Turn your transceiver off wherever posted notices restrict the use of radios or cellular telephones. Facilities such as hospitals may use equipment that is sensitive to RF energy.
- Turn your transceiver off on board aircraft when requested to do so.
- Do not place your hand-held radio in front of a vehicle's air-bag. If the air-bag deploys, it could propel the transceiver like a projectile causing bodily injury.

Troubleshooting

Problem	Possible cause	Correction
No transmission while pressing the PTT Button	Weak batteries (mobile unit)	Charge or replace batteries
	Incorrect battery polarity (mobile unit)	Install the batteries following the directions in paragraph Installing the Batteries.
Weak or no signal received	Weak batteries (mobile unit)	Charge or replace batteries
	Channel and privacy code not set the same as target transceiver	Adjust the transceiver's settings to match those settings of the target transceiver
	Volume level too low PTT Button inadvertently depressed	Increase volume level Release PTT Button
	Excessive radio interference on a particular channel Obstruction of radio signal	Change to a different channel Avoid operating in or near large buildings or vehicles
Unit beeps, but will not function when turned on	Batteries extremely discharged (mobile unit)	Charge or replace batteries
Reception of unwanted signals	CTCSS privacy mode not on	Turn on the CTCSS privacy mode and set code number to match the setting of the target transceiver.
	Interference from electronic devices such as computers or TVs	Turn the devices off or move farther away from them.

Technical Specifications:

General

Frequency Range:	
Channel 1-7 (Shared with FRS)	Refer to Frequency Chart
Channel 8-14 (FRS only)	Refer to Frequency Chart
Channel 15-22 (GMRS only)	Refer to Frequency Chart
Channel Spacing	12.5 kHz
Privacy Codes	38 for each main channel
Dimensions (W x D x H):	
Handset	2.10 in x 1.10 in x 3.86 in 53.4 mm x 28.0 mm x 98.0 mm
Base Unit	6.3 in x 4.7 in x 2.15 in 160mm x 120 mm x 55mm

Power Supply

Power Source:	
Handset	Alkaline Batteries, AAA (4), 6 VDC Ni-MH rechargeable, AAA (4), 4.8 VDC, 650 mAh
Operating Time	30 hours @ LO pwr (Alkaline Batteries) 14 hours @ HI pwr
Duty Cycle:	(Xmit:Rcve:Stby) (5: 5: 90 ratio)
Base Unit	AC Wall Adapter, P/N (P/N F30ADP) (supplied): Input: 120 VAC Output: 9.0 VDC, 1000 mA

Receiver

Useable Sensitivity	>-119 dBm
Maximum Audio Output Power	> .03 Watt maximum (8 Ohm)
Modulation Distortion	< 5% (1 kHz 70%)

Transmitter

RF Output Power	0.5 Watt maximum (LO setting); 1.8 Watts maximum (HI setting)
Maximum Deviation	<+/- 2.5 kHz
Modulation Distortion	< 5% (1 kHz 70%)

25

128-6476
25 of 28

Main Channel Frequencies:

CHANNEL/TYPE	FREQ (MHz)	CHANNEL/TYPE	FREQ (MHz)
1 GMRS/FRS	462.5625	12 FRS	467.6625
2 GMRS/FRS	462.5875	13 FRS	467.6875
3 GMRS/FRS	462.6125	14 FRS	467.7125
4 GMRS/FRS	462.6375	15 GMRS	462.5500
5 GMRS/FRS	462.6625	16 GMRS	462.5750
6 GMRS/FRS	462.6875	17 GMRS	462.6000
7 GMRS/FRS	462.7125	18 GMRS	462.6250
8 FRS	467.5625	19 GMRS	462.6500
9 FRS	467.5875	20 GMRS	462.6750
10 FRS	467.6125	21 GMRS	462.7000
11 FRS	467.6375	22 GMRS	462.7250

NOTE: Channels 1 through 7 are shared with FRS radios.
Channels 8 through 14 are FRS only.
Channels 15 through 22 are GMRS only.

Weather Channel Frequencies:

Channel	Freq. MHz	Channel	Freq. MHz
1	162.550	6	162.500
2	162.400	7	162.525
3	162.475	8*	161.650
4	162.425	9*	161.775
5	162.450	10*	163.275

*Canadian Marine

CTCSS Tone Frequencies (in Hz)

CTCSS	Freq. Hz	CTCSS	Freq. Hz
1	67.0	20	131.8
2	71.9	21	136.5
3	74.4	22	141.3
4	77.0	23	146.2
5	79.7	24	151.4
6	82.5	25	156.7
7	85.4	26	162.2
8	88.5	27	167.9
9	91.5	28	173.8
10	94.8	29	179.9
11	97.4	30	186.2
12	100.0	31	192.8
13	103.5	32	203.5
14	107.2	33	210.7
15	110.9	34	218.1
16	114.8	35	225.7
17	118.8	36	233.6
18	123.0	37	241.8
19	127.3	38	250.3

* oF = No Tone

90 DAY LIMITED WARRANTY

Applies to Audiovox Family Radio and General Mobile Service Products.

AUDIOVOX CORPORATION (the Company) warrants to the original retail purchaser of this product that should this product or any part thereof, under normal use and conditions, be proven defective in material or workmanship within 90 days from the date of original purchase, such defect(s) will be repaired or replaced with new or reconditioned product (at the Company's option) without charge for parts and repair labor.

To obtain repair or replacement within the terms of this Warranty, the product is to be delivered with proof of warranty coverage (e.g. dated bill of sale), specification of defect(s), transportation prepaid, to the warranty center at the address shown below.

The Company disclaims liability for communications range of this product.

This Warranty does not apply to any product or part thereof which, in the opinion of the Company, has suffered or been damaged through alteration, improper installation, mishandling, misuse, neglect, accident, or by removal or defacement of the factory serial number/bar code label(s). THE EXTENT OF THE COMPANY'S LIABILITY UNDER THIS WARRANTY IS LIMITED TO THE REPAIR OR REPLACEMENT PROVIDED ABOVE AND, IN NO EVENT, SHALL THE COMPANY'S LIABILITY EXCEED THE PURCHASE PRICE PAID BY PURCHASER FOR THE PRODUCT.

This Warranty is in lieu of all other express warranties or liabilities. ANY IMPLIED WARRANTIES, INCLUDING ANY IMPLIED WARRANTY OF MERCHANTABILITY, SHALL BE LIMITED TO THE DURATION OF THIS WRITTEN WARRANTY. ANY ACTION FOR BREACH OF ANY WARRANTY HEREUNDER INCLUDING ANY IMPLIED WARRANTY OF MERCHANTABILITY MUST BE BROUGHT WITHIN A PERIOD OF 30 MONTHS FROM DATE OF ORIGINAL PURCHASE. IN NO CASE SHALL THE COMPANY BE LIABLE FOR ANY CONSEQUENTIAL OR INCIDENTAL DAMAGES FOR BREACH OF THIS OR ANY OTHER WARRANTY, EXPRESS OR IMPLIED, WHATSOEVER. No person or representative is authorized to assume for the Company any liability other than expressed herein in connection with the sale of this product.

Some states do not allow limitations on how long an implied warranty lasts or the exclusion or limitation of incidental or consequential damage so the above limitations or exclusions may not apply to you. This Warranty gives you specific legal rights and you may also have other rights which vary from state to state.

AUDIOVOX CORPORATION, 150 MARCUS BLVD., HAUPPAUGE, NEW YORK 11788
1-800-290-6650 128-5385A