



# SuperStack® II Switch 3900 Getting Started Guide



<http://www.3com.com/>

Part No. 10005622  
Published April 1998

---

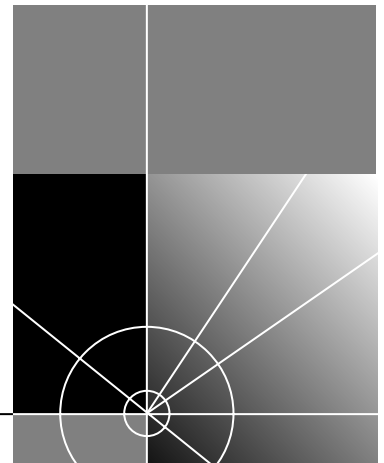

Copyright © 1998, 3Com Corporation. All rights reserved. No part of this documentation may be reproduced in any form or by any means or used to make any derivative work (such as translation, transformation, or adaptation) without written permission from 3Com Corporation.

3Com Corporation reserves the right to revise this documentation and to make changes in content from time to time without obligation on the part of 3Com Corporation to provide notification of such revision or change.

3Com Corporation provides this documentation without warranty of any kind, either implied or expressed, including, but not limited to, the implied warranties of merchantability and fitness for a particular purpose. 3Com may make improvements or changes in the product(s) and/or the program(s) described in this documentation at any time.

#### UNITED STATES GOVERNMENT LEGENDS

*If you are a United States government agency, then this documentation and the software described herein are provided to you subject to the following:*

All technical data and computer software are commercial in nature and developed solely at private expense. Software is delivered as "Commercial Computer Software" as defined in DFARS 252.227-7014 (June 1995) or as a "commercial item" as defined in FAR 2.101(a) and as such is provided with only such rights as are provided in 3Com's standard commercial license for the Software. Technical data is provided with limited rights only as provided in DFAR 252.227-7015 (Nov 1995) or FAR 52.227-14 (June 1987), whichever is applicable. You agree not to remove or deface any portion of any legend provided on any licensed program or documentation contained in, or delivered to you in conjunction with, this User Guide.

#### EMISSIONS COMPLIANCE STATEMENTS FOR CLASS A PRODUCTS

##### United States — Federal Communications Commission Notice

This equipment has been tested and found to comply with the limits for a Class A digital device, pursuant to Part 15 of the FCC Rules. These limits are designed to provide responsible protection against harmful interference when the equipment is operated in a commercial environment. This equipment generates, uses, and can radiate radio frequency energy and, if not installed and used in accordance with the instruction manual, may cause harmful interference to radio communications. Operation of this equipment in a residential area is likely to cause harmful interference, in which case the user will be required to correct the interference at his or her own expense.

##### Canada — Emissions Requirements

This Class A digital apparatus meets all requirements of the Canadian Interference-Causing Equipment Regulations.

Cet appareil numérique de la classe A respecte toutes les exigences du Règlement sur le matériel brouilleur du Canada.

##### Japan — VCCI Class A Compliance

この装置は、情報処理装置等電波障害自主規制協議会（VCCI）の基準に基づくクラスA情報技術装置です。この装置を家庭環境で使用すると電波妨害を引き起こすことがあります。この場合には使用者が適切な対策を購ずるよう要求されることがあります。

This is a Class A product based on the standard of the Voluntary Control Council for Interference by Information Technology Equipment (VCCI). If this equipment is used in a domestic environment, radio disturbance may arise. When such trouble occurs, the user may be required to take corrective actions.

## **EMC DIRECTIVE COMPLIANCE**

This equipment was tested and found to conform to the Council Directive 89/336/EEC for electromagnetic compatibility. Conformity with this Directive is based upon compliance with the following harmonized standards:

EN 55022 Limits and Methods of Measurement of Radio Interference

EN 50082-1 Electromagnetic Compatibility Generic Immunity Standard: Residential, Commercial, and Light Industry

**Warning:** This is a Class A product. In a domestic environment, this product may cause radio interference, in which case you may be required to take adequate measures.

## **LOW VOLTAGE DIRECTIVE COMPLIANCE**

This equipment was tested and found to conform to the Council Directive 72/23/EEC for safety of electrical equipment. Conformity with this Directive is based upon compliance with the following harmonized standard:

EN 60950 Safety of Information Technology Equipment

## **UK GENERAL APPROVAL STATEMENT**

This equipment is manufactured to the international Safety Standard EN60950 and is approved in the UK under the General Approval Number NS/G/12345/J/100003 for indirect connection to the public telecommunication network.

## **AUSTRALIAN EMC FRAMEWORKS COMPLIANCE**

This product conforms to the EMC Frameworks and meets the Class A limits of AS3548.

## **TRADEMARKS**

Unless otherwise indicated, 3Com registered trademarks are registered in the United States and may or may not be registered in other countries.

3Com, the 3Com logo, SuperStack, and Transcend are registered trademarks of 3Com Corporation. 3ComFacts is a service mark of 3Com Corporation.

IBM and NetView AIX are registered trademarks of International Business Machines Corporation. Apple, AppleTalk, and Macintosh are trademarks of Apple Computer, Inc. Ultrajet is a trademark of Chemtronics. CompuServe is a registered trademark of CompuServe, Inc. MS-DOS and Windows are registered trademarks of Microsoft Corporation. HP and OpenView are registered trademarks of Hewlett-Packard Co. SunNet Manager, SunOS, and OpenWindows are trademarks of Sun Microsystems, Inc. Microswabs and Texwipe are registered trademarks of Texwipe. Liqui-Tool is a trademark of Triangle Tool Group. UNIX is a registered trademark in the United States and other countries, licensed exclusively through X/Open Company.

All other company and product names may be trademarks of the respective companies with which they are associated.



# CONTENTS

---

## ABOUT THIS GUIDE

Introduction	1
Finding Specific Information in This Guide	1
Conventions	2
SuperStack II Switch 3900 Documentation	3
Paper Documents	3
Documents on CD-ROM	4
Related Publications	4
Documentation Comments	4
Year 2000 Compliance	5

---

## 1 SWITCH 3900 SYSTEM AND SETUP OVERVIEW

Switch 3900 Intelligent Switch	1-1
System Overview — 24-Port Front Panel	1-2
System Overview — 36-Port Front Panel	1-3
System Overview — Back Panel of Both Models	1-4
System Features and Benefits	1-5
System Management	1-5
Optional Gigabit Ethernet Modules	1-6
Network Configuration Example	1-6
Providing Dedicated Links for Fast Ethernet	1-6
Network Configuration Sample	1-7

---

## 2 INSTALLING THE SYSTEM

Before You Begin	2-1
Installing the System on a Table Top or in a Free-Standing Stack	2-2
Installing the System in a Distribution Rack	2-3
Preparing the System and Rack	2-3
Mounting the System into a Distribution Rack	2-5

---

## 3 CABLING SWITCH 3900 PORTS

Overview of Cabling	3-1
Fiber Safety Precautions	3-1
Fast Ethernet Ports	3-2
Cabling 10/100BASE-TX (RJ-45) Ports	3-2
10/100BASE-TX (RJ-45) Connector Pin Assignments	3-3
Gigabit Ethernet Ports	3-4
Cabling Gigabit Ethernet Ports	3-4
Cabling the Console Port	3-5
Console Port Pin Assignments	3-7

---

## 4 SYSTEM POWER UP

Power Options	4-1
AC Power Cord	4-1
Optional Advanced Redundant Power System	4-1
Optional Uninterruptible Power System	4-1

Power Up	4-2
To Power the Switch 3900 with the RPS	4-2
To Power the Switch 3900 from the Wall Receptacle	4-2
Power-up Diagnostics	4-2
System Diagnostics	4-3
Power LED Activity	4-3
Fault LED Activity	4-3
Ethernet Port Diagnostics	4-3
Packet LED Activity	4-3
Status LED Activity	4-3
System and Port Status LEDs	4-4
System Checks	4-5
Next Step: Software Configuration	4-5

---

## 5 QUICK SETUP FOR MANAGEMENT ACCESS

About Switch 3900 System Management	5-1
How Do You Want to Manage the System?	5-1
Terminal Connection	5-2
Modem Connection	5-2
IP Management Interface	5-2
Initial Management Access	5-2
Setting the Console Port Baud	5-3
Configuring the IP Interface	5-3

---

## 6 TROUBLESHOOTING THE SYSTEM

Getting Additional Help	6-1
Diagnosing Problems	6-1
Power Failures	6-1
Abnormal LED Activity	6-1
Cleaning Dirty Fiber Optic Ports and Connectors	6-4

---

## A SYSTEM SPECIFICATIONS

---

### B SITE REQUIREMENTS AND SAFETY CODES

General Safety Requirements	B-1
Wiring Closet Recommendations	B-1
Distribution Rack Requirements	B-2
Protective Grounding for the Rack	B-2
Space Requirements for the Rack	B-2
Mechanical Requirements for the Rack	B-3
Building and Electrical Codes	B-4
Building Codes	B-4
Electrical Codes	B-5

---

### C TECHNICAL SUPPORT

Online Technical Services	C-1
World Wide Web Site	C-1
3Com FTP Site	C-1
3Com Bulletin Board Service	C-1
Access by Analog Modem	C-2
Access by Digital Modem	C-2
3ComFacts Automated Fax Service	C-2
Support from Your Network Supplier	C-2
Support from 3Com	C-3
Returning Products for Repair	C-4

---

## INDEX

---

## 3COM CORPORATION LIMITED WARRANTY

# ABOUT THIS GUIDE

## Introduction

Your *SuperStack II Switch 3900 Getting Started Guide* provides all the information that you need to set up your SuperStack® II Switch 3900 system and get it operating in your network. This guide provides an overview of your system and step-by-step procedures for planning your configuration, installing your system, cabling, powering up, configuring, and troubleshooting. When you are ready to configure your SuperStack II Switch 3900 system, see the *Administration Guide* on the Documentation CD.



*If the information in the Software Installation and Release Notes that are shipped with your Switch 3900 system differs from the information in this guide, follow the instructions in the Release Notes.*

This guide is intended for the system or network administrator who is responsible for installing and managing network hardware. It assumes that you have a working knowledge of local area network (LAN) operations, but it does not assume prior knowledge of 3Com's Switch 3900 high-performance networking equipment.

Most user guides and release notes are available in Adobe Acrobat Reader Portable Document Format (PDF) or HTML on the 3Com World Wide Web site:

<http://www.3com.com>

## Finding Specific Information in This Guide

This table shows where to find specific information.

For information on	Turn to
Best ways to use the Switch 3900 system	"System Features and Benefits" on page 1-5
The front and back panels	"System Overview — 24-Port Front Panel" starting on page 1-2
Site requirements and other issues to consider before installing your Switch 3900 system	"General Safety Requirements" on page B-1
Installing the system on a table or in a distribution rack	"Installing the System on a Table Top or in a Free-Standing Stack" starting on page 2-2 and "Installing the System in a Distribution Rack" on page 2-3
Cabling rules and pin assignments:	
■ Fast Ethernet ports	"Fast Ethernet Ports" on page 3-2
■ Gigabit Ethernet ports	"Gigabit Ethernet Ports" on page 3-4
■ Console port	"Cabling the Console Port" on page 3-5 and "Console Port Pin Assignments" on page 3-7
Checking system power-up diagnostics and LEDs	"Power Up" on page 4-2



(continued)

For information on	Turn to
Deciding how to manage your system	"How Do You Want to Manage the System?" on page 5-1
Setting the Console port baud	"Setting the Console Port Baud" on page 5-3
Configuring the IP management interface	"Configuring the IP Interface" on page 5-3
Troubleshooting hardware and software problems	"Diagnosing Problems" on page 6-1
Complying with environmental and compliance specifications	Appendix A: System Specifications
Checking your site for environmental and safety considerations	Appendix B: Site Requirements and Safety Codes
Getting help from your network supplier or 3Com	Appendix C: Technical Support

## Conventions

Table 1 and Table 2 list conventions that are used throughout this guide.

**Table 1** Notice Icons

Icon	Type	Description
	Information Note	Information that describes important features or instructions
	Caution	Information that alerts you to potential loss of data or damage to an application, system, or device
	Warning	Information that alerts you to potential personal injury

**Table 2** Text Conventions

Convention	Description
Screen displays	This typeface represents information as it appears on the screen.
<b>Commands</b>	<p>The word "command" means that you must enter the command exactly as shown and then press Return or Enter. Commands appear in bold. Example:</p> <p>To update the system software, enter the following command:</p> <p><b>system softwareUpdate</b></p> <p> <i>This guide always gives the full form of a command in uppercase and lowercase letters. However, you can abbreviate commands by entering the fewest letters in each command that identify a unique command. Commands are not case sensitive.</i></p>
The words "enter" and "type"	When you see the word "enter" in this guide, you must type something, and then press Return or Enter. Do not press Return or Enter when an instruction simply says "type."
Keyboard key names	<p>If you must press two or more keys simultaneously, the key names are linked with a plus sign (+). Example:</p> <p>Press Ctrl+Alt+Del</p>
Words in <i>italics</i>	<p>Italics are used to:</p> <ul style="list-style-type: none"> <li>■ Emphasize a point.</li> <li>■ Denote a new term at the place where it is defined in the text.</li> <li>■ Identify menu names, menu commands, and software button names. Examples: From the <i>Help</i> menu, select <i>Contents</i>. Click <i>OK</i>.</li> </ul>



## SuperStack II Switch 3900 Documentation

The following documents comprise the SuperStack II Switch 3900 documentation set. Documents are shipped with your system in one of two forms:

- Paper documents that are shipped with your system or with optional components. They are listed in the next section.
- SuperStack II 3900 and 9300 Documentation CD with online versions of the paper documents

To order a paper copy of a document that you see on the compact disc, or to order additional compact discs, contact your sales representative.

### Paper Documents

These documents are shipped with your SuperStack II Switch 3900 system:

- *SuperStack II Switch 3900 and 9300 Unpacking Instructions*  
How to unpack your Switch 3900 system. Also, an inventory list of items that are shipped with your system.
- *SuperStack II Switch 3900 and 9300 Software Installation and Release Notes*  
All of the new features, system issues, known problems, and software corrections for the software release. It also describes any changes to the Switch 3900 system's documentation.

- *SuperStack II Switch 3900 and 9300 Quick Installation Guide*

How to perform a quick installation of your system. For more details on installation, see the *SuperStack II Switch 3900 Getting Started Guide*.

- *SuperStack II Switch 3900 Getting Started Guide*

All the procedures necessary for getting your system up and running, including information on installing, cabling, powering up, configuring, and troubleshooting the system.

- *SuperStack II Switch 3900 and 9300 Command Quick Reference Card*

All of the Administration Console switching commands for the Switch 3900. For complete descriptions, see the *Administration Guide*.

These documents are shipped with optional devices:

- *1000BASE-SX/1000BASE-LX Gigabit Ethernet Module Installation Guide*

How to install the optional Gigabit Ethernet module.

- *SuperStack II Switch Advanced RPS User Guide*

How to install the Advanced Redundant Power Supply (RPS) and how to use it to provide redundant and resilient power supplies for the Switch 3900.

- *SuperStack II Switch Advanced RPS 'Y' Cable Type 2 User Guide*

How to install the Y cable with the Advanced Redundant Power Supply (RPS) to provide fully redundant capabilities.

## Documents on CD-ROM

The compact disc that comes with your system contains these documents:

- Online versions of the paper documents that are shipped with your system and its components
- *SuperStack II Switch 3900 and 9300 Administration Guide*

How to use the Administration Console and the management tasks that you can perform using it.

---

## Related Publications

Depending on how you install and manage your system, several related documents can provide helpful information:

- SNMP Network Manager documents

The Switch 3900 uses SNMP (Simple Network Management Protocol), which can be accessed by a remote network management application. 3Com has network management applications for a variety of platforms. Contact your supplier for current product information. Each network management application includes a guide that explains how to manage your system.

If you are using network management software from another vendor, refer to the sections of the product's documentation that describe how to manage SNMP devices.

- SNMP documents

3Com recommends these books for easy-to-read descriptions of SNMP:

- Marshall T. Rose. *The Simple Book: An Introduction to Networking Management*. Englewood Cliffs, NJ: Prentice-Hall; 1996.
- "Introduction to SNMP" Self-Study Guide. Order from 3Com: Part Number 3CS-350A.
- Telnet documents

To manage the Switch 3900 system over a TCP/IP network using telnet, see the documentation that is supplied with your telnet application.

---

## Documentation Comments

Your suggestions are very important to us. They help us make our documentation more useful to you.

Please send e-mail comments about this guide to:

[sdtechpubs\\_comments@3Com.com](mailto:sdtechpubs_comments@3Com.com)

Please include the following information when commenting:

- Document title
- Document part number (found on front or back page of document)
- Page number (if appropriate)

Example:

*SuperStack II Switch 3900 Getting Started Guide*  
*Part Number 10005622*  
*Page 2-5 (chapter 2, page 5)*

---

## Year 2000 Compliance

For information on Year 2000 compliance and 3Com products, visit the 3Com Year 2000 Web page:

<http://www.3com.com/products/yr2000.html>



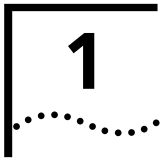

# SWITCH 3900 SYSTEM AND SETUP OVERVIEW

This chapter contains:

- An overview of 3Com's SuperStack® II Switch 3900 and how it provides solutions for your network
- A description of the major features and components of the system
- A network configuration example

---

## Switch 3900 Intelligent Switch

The Switch 3900 is the ideal product for network managers who want to migrate from existing switched 10 Mb networks to switched 100 Mb or who need to deliver faster access to servers.

The Switch 3900 provides superior workgroup and departmental switching performance with the added flexibility of multiple Gigabit Ethernet links and server connections.

The SuperStack II Switch 3900 family delivers full line rate, nonblocking switching between 10/100 Mb links and 1000 Mb Gigabit Ethernet links.

The Switch 3900 family consists of two models:

- **3C39024** — The 24-port 10/100BASE-TX switch, with up to three Gigabit Ethernet links. See Figure 1-1.
- **3C39036** — The 36-port 10/100BASE-TX switch, with up to three Gigabit Ethernet links. See Figure 1-2.

Both versions of the Switch 3900 provide:

- One built-in Gigabit Ethernet multimode fiber (MMF) link (1000BASE-SX)
- Expansion slots on the back panel (see Figure 1-3) that can hold one or two of these optional Gigabit Ethernet modules:
  - **Model 3C39001** — 1000BASE-SX for multimode fiber (MMF)
  - **Model 3C39002** — 1000BASE-LX for single-mode fiber (SMF)

The cables for all Gigabit Ethernet ports use laser transmission and have SC connectors.

See "Optional Gigabit Ethernet Modules" on page 1-6 for more information.

## System Overview — 24-Port Front Panel

### Ethernet Ports

Provide 24 10/100BASE-TX (RJ-45) Ethernet ports

### System and Port LEDs

Provide information about the system and each port

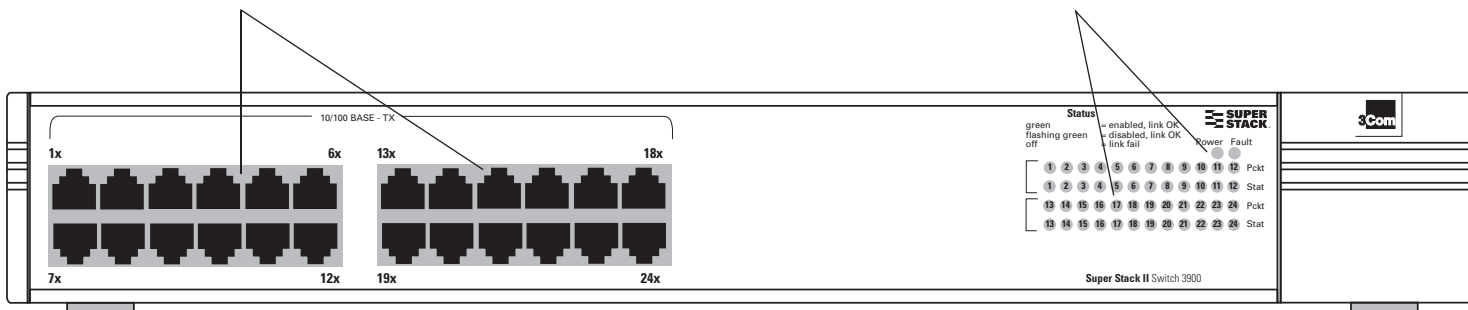

**Figure 1-1** Front Panel of the 24-Port SuperStack II Switch 3900

# System Overview — 36-Port Front Panel

**Ethernet Ports**  
Provide 36 10/100BASE-TX (RJ-45) Ethernet ports

**System and Port LEDs**  
Provide information about the system and each port

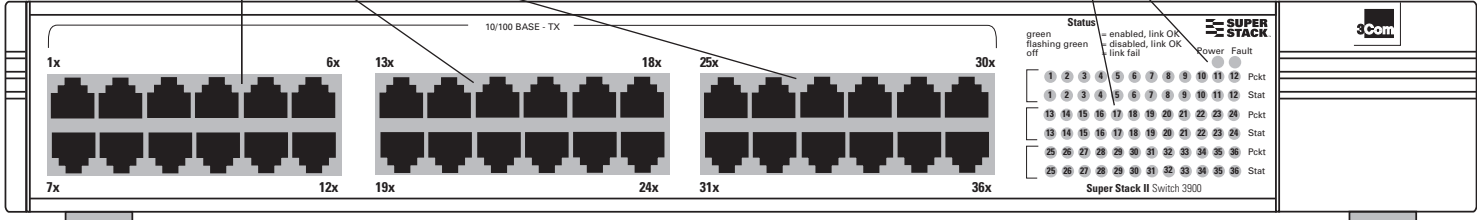
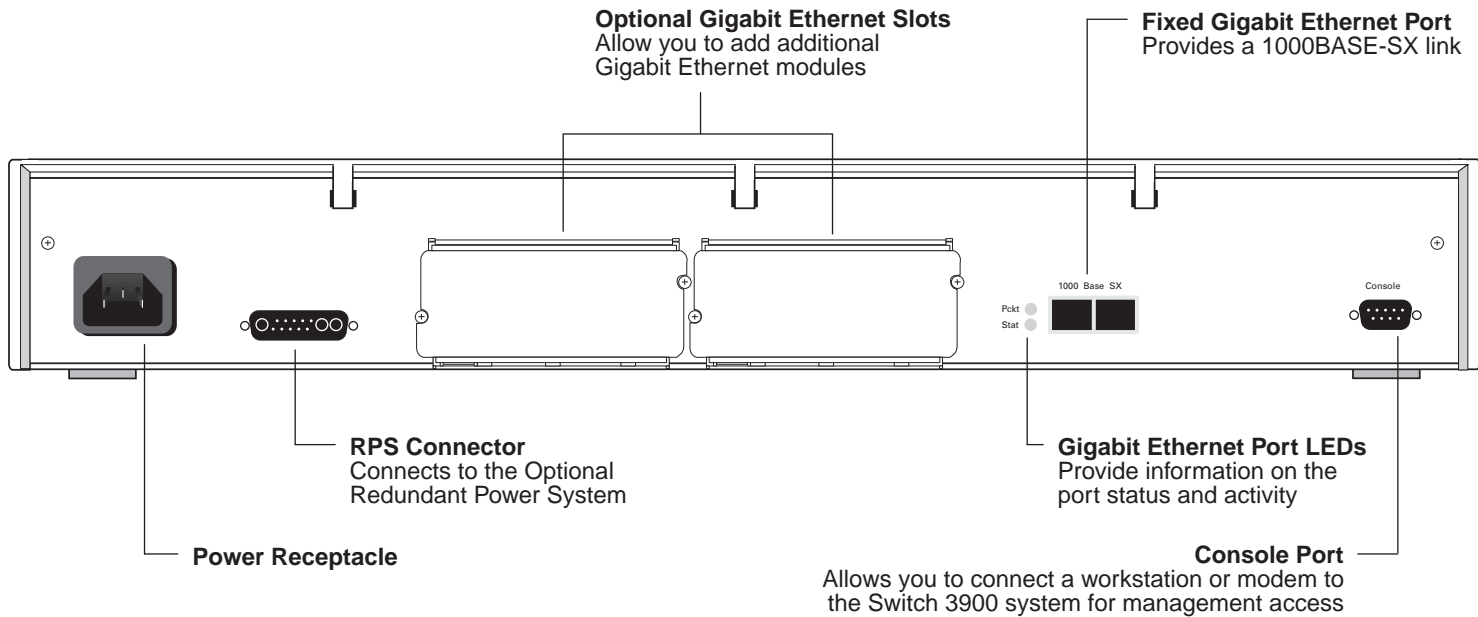

Figure 1-2 Front Panel of the 36-Port SuperStack II Switch 3900

## System Overview — Back Panel of Both Models



**Figure 1-3** Back Panel of the 24-Port and 36-Port SuperStack II Switch 3900



---

## System Features and Benefits

The Switch 3900 is part of 3Com's SuperStack family. To combine diverse technologies as your network grows, install the Switch 3900 in a SuperStack network.

Some key features of the SuperStack II Switch 3900 system:

- High-density Gigabit Ethernet and Fast Ethernet configurations  
The Switch 3900 has 24 or 36 Fast Ethernet ports and up to three Gigabit Ethernet links.
- Autonegotiation support  
The Switch 3900 supports 10BASE-T/100BASE-TX and full-duplex and half-duplex autonegotiation on all front panel ports.
- Multiple-link trunking for Gigabit Ethernet and Fast Ethernet links  
You can choose the performance level of links between switches, even scaling beyond one Gigabit.
- IGMP Snooping  
The Switch 3900 conserves the network bandwidth that is consumed by audio and video applications by keeping IP multicast traffic isolated to specific ports.

- Trunking links, Spanning Tree, and Advanced Redundant Power Supply (RPS) support

The Switch 3900 protects against cable and equipment failures with Spanning Tree Protocol and trunking links. The optional RPS protects against power interruptions for fault-tolerant networks.

- Manageability

The Switch 3900 provides full support for VLANs, Fast IP, and RMON Version 1, as well as a roving analysis port through SNMP management.

## System Management

Switch 3900 systems include integrated management to provide fault tolerance and maximum network availability. This management is accessible in two ways:

- Switch 3900 Administration Console
- Standard network managers based on SNMP, such as 3Com's Transcendware, Sun's SunNet Manager, HP OpenView, and IBM's NetView AIX applications

---

## Optional Gigabit Ethernet Modules

The Switch 3900 back panel has two expansion slots that can hold optional Gigabit Ethernet modules. These modules are available in the following configurations:

- **1000BASE-SX Module** — Multimode fiber with paired SC connectors. It supports links of up to 260 meters (852 feet) over 62.5-micron multimode fiber or up to 525 meters (1722 feet) over 50-micron multimode fiber.
- **1000BASE-LX Module** — Single-mode fiber with paired SC connectors. It supports links of up to 3.0 kilometers (1.86 miles) over 8-micron to 10-micron single-mode fiber.

The modules have the same physical configuration and are installed in the same way.

For more information about installing and using the optional Gigabit Ethernet modules, see the *1000BASE-SX/1000BASE-LX Gigabit Ethernet Module Installation Guide* that is on the Documentation CD and shipped with either module.

---

## Network Configuration Example

This section describes one way to place the Switch 3900 in your network to alleviate traffic congestion.

### Providing Dedicated Links for Fast Ethernet

The rapid deployment of Fast Ethernet has increased bandwidth demand many times over, not only by supporting 100 Mb connections on the network but also by placing demands on the servers to manage the traffic coming through those connections.

Figure 1-4 shows how the Switch 3900 provides direct 100 Mb links to devices on the network through its Fast Ethernet ports and up to three dedicated Gigabit links to your network's servers.

In this sample configuration, the Switch 3900 can provide up to 36 clients on your network with a dedicated 100 Mb link and can multiplex the client traffic for Gigabit-speed access to the servers. (You can use one port on the Switch 3900 for in-band management as well as for network traffic.)

---

## Network Configuration Sample

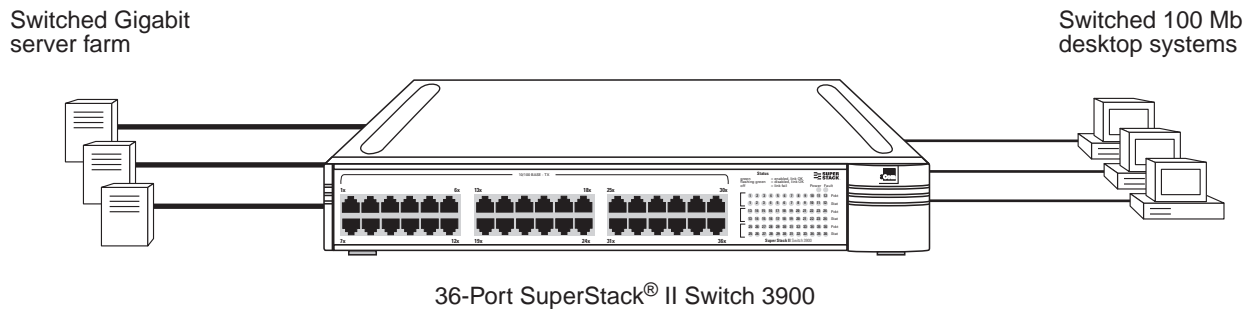

**Figure 1-4** SuperStack II Switch 3900 Provides Dedicated Fast Ethernet Links



# 2

## INSTALLING THE SYSTEM

This chapter describes how to install your SuperStack® II Switch 3900 on a table top, in a free-standing stack with other SuperStack II products, or in a distribution rack.



See Appendix B for site requirements.

- To install the Switch 3900 system on a table top or in a free-standing stack, read these sections:
  - “Before You Begin” (the next section)
  - “Installing the System on a Table Top or in a Free-Standing Stack” on page 2-2
- To install the Switch 3900 system in a distribution rack, read these sections:
  - “Before You Begin” (the next section)
  - “Installing the System in a Distribution Rack” on page 2-3

### Before You Begin

Before you begin this procedure, be sure to:

- Move the Switch 3900 system close to where you plan to install it.



*Install the system near an easily accessible power outlet. You can power down the system only by removing the power cord from the power source.*

- Have a No. 1 Phillips screwdriver available.
- Have the system mounting kit available. See Table 2-1.

**Table 2-1** Switch 3900 System Mounting Kit

Qty	Item	To use in
4	Rubber feet (self-adhesive)	Stacking the system on a table or in a stack
2	Mounting brackets	Installing the system in a distribution rack
6	M4 x 10 pan-head screws	Installing the distribution rack brackets

## Installing the System on a Table Top or in a Free-Standing Stack

To install the Switch 3900 system on a table top or in a free-standing stack, follow these instructions:

- 1 See Appendix B for site requirements.
- 2 Turn the system on its side.
- 3 Remove the protective covering from the rubber feet.
- 4 Place one rubber foot in each marked area at the four corners of the unit.
- 5 Turn the system onto its feet.
- 6 Verify that the air intake vents and fan exhaust vents at the sides of the system are not blocked.

To install the system into a free-standing stack, place the system on top of another. Be sure that the rubber feet of the upper unit fit securely in the recesses in the top of the lower unit. See Figure 2-1.



**CAUTION:** Stack no more than eight SuperStack II systems in a single free-standing stack.

You are now ready to cable your system. For instructions, see Chapter 3.

Place the feet of one system into the mounting recesses of the system below it.

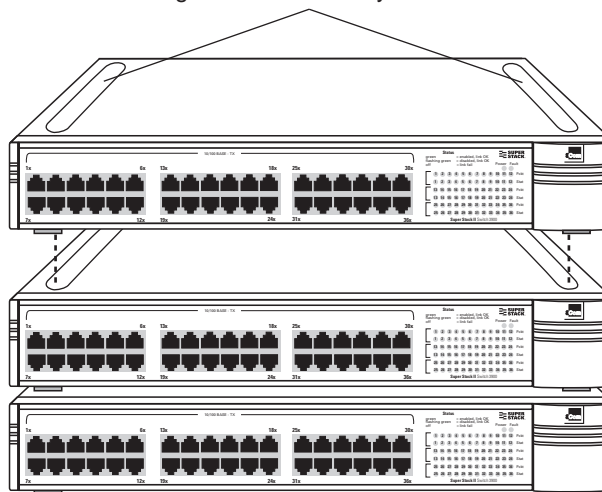

**Figure 2-1** Stacking the Switch 3900

## Installing the System in a Distribution Rack

You can mount the system into a 19-inch distribution rack. This section describes how to prepare the system and distribution rack for installation and how to mount the system in the rack.



*Install your distribution rack near an easily accessible power outlet. You can power down the system only by removing the power cord from the power source.*

### Preparing the System and Rack

To prepare the system and distribution rack for installing the Switch 3900 system:

- 1 See Appendix B for distribution rack requirements.
- 2 Attach the mounting brackets to the left and right sides of the system using the M4 x 10 mounting bracket screws. See Figure 2-2.

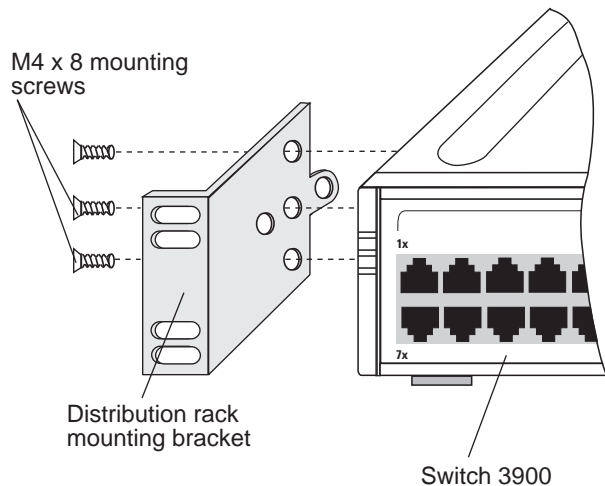

**Figure 2-2** Installing System Mounting Brackets

- 3 Locate the top of a universal mounting hole pattern on either mounting rail of the distribution rack. In this pattern, the spacing between holes is  $\frac{1}{2}$  inch,  $\frac{5}{8}$  inch,  $\frac{5}{8}$  inch, and  $\frac{1}{2}$  inch.

To find the top of the pattern, locate the midpoint between any two holes that are spaced  $\frac{1}{2}$  inch apart. Figure 2-3 shows the universal mounting hole pattern.

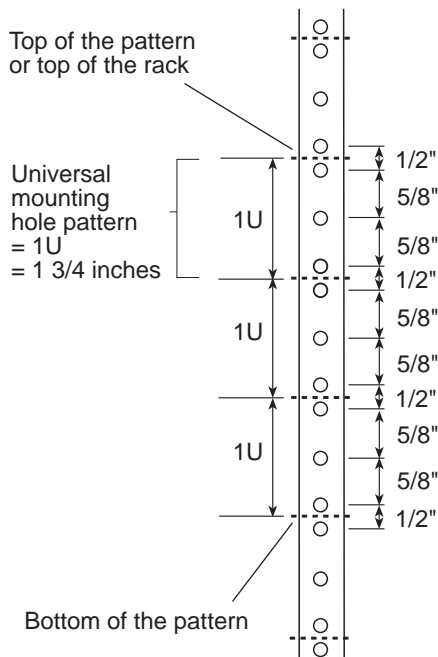

**Figure 2-3** Universal Mounting Hole Pattern

**4** Determine which holes to use to mount your system.

Two Switch 3900s are designed to mount in any 3U space of the rack (that is, the space occupied by three instances of the universal mounting hole pattern).

Figure 2-4 illustrates the positions of two Switch 3900s, one attached to holes 1 and 4 and the other attached to holes 6 and 9.

To mount only one Switch 3900, use either position.

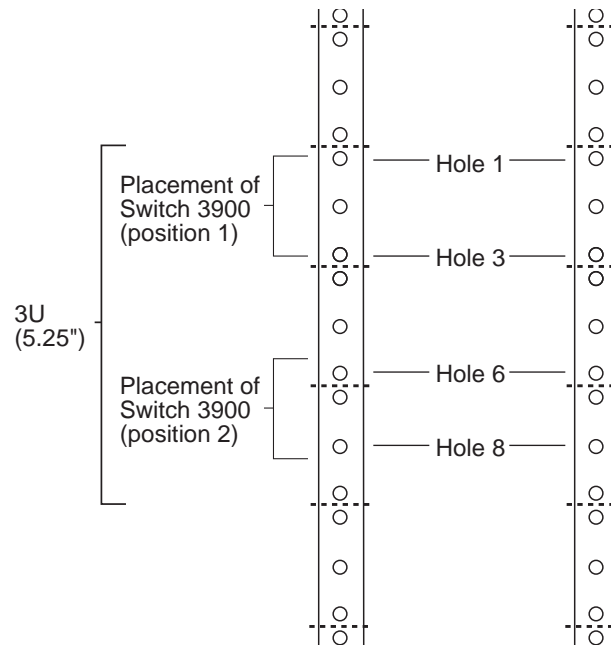

**Figure 2-4** Placement of Switch 3900s in a Distribution Rack

**5** Repeat the process on the other rail.



*Be sure to select holes that are parallel to each other on the mounting rails.*



### Mounting the System into a Distribution Rack

To mount the system into a distribution rack:

- 1 Carefully lift the system into place and align the appropriate holes in the mounting brackets with the designated holes in the distribution rack. See Figure 2-5.

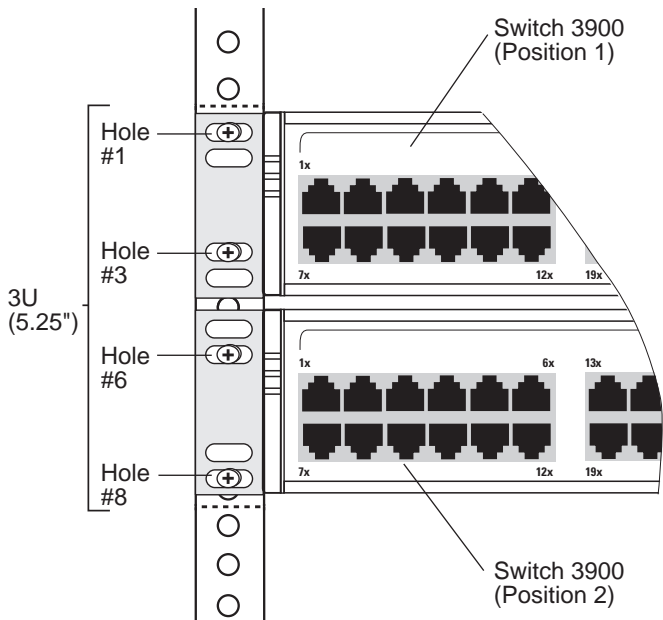

Figure 2-5 Aligning Bracket and Distribution Rack Holes

- 2 Have another person hold the system in place. Insert the four suitable mounting screws (not provided) into the designated mounting holes on the bracket. Repeat for the other side.
- 3 Verify that the system is level.

- 4 Tighten the mounting screws. The system is now installed in the distribution rack.

Figure 2-6 shows two Switch 3900 systems installed in a distribution rack.

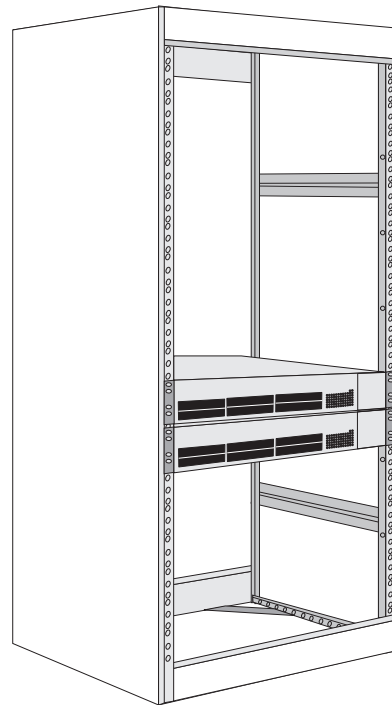

Figure 2-6 Two Systems Installed in a Rack

You are now ready to cable the system. For cabling instructions, see Chapter 3.



# 3

## CABLING SWITCH 3900 PORTS

This chapter describes how to cable your SuperStack® II Switch 3900 system for connection to the network. It gives an overview of module cabling and describes how to cable:

- Fast Ethernet ports
- Gigabit Ethernet ports
- System console port

When all your Ethernet, Gigabit Ethernet, and system network connections are complete, see Chapter 4.



*If you are staging the system, you do not need to connect it to the network at this point. See Chapter 4 to start your system before you cable it.*

### Overview of Cabling

The Switch 3900 system is a fixed-configuration LAN switch with:

- 24 or 36 shielded, 10/100BASE-TX (RJ-45) Ethernet ports on the front panel
- One fixed Gigabit Ethernet port on the back panel
- Two Gigabit Ethernet expansion slots for optional Gigabit Ethernet modules on the back panel

### Fiber Safety Precautions

SuperStack II Switch 3900 modules use lasers in their fiber optic ports. To ensure your safety when you install or work with these modules, comply with the following precautions.



**WARNING:** *The fiber optic lasers used in these modules meet the regulatory requirements for casual exposure to the eye. As with any source of bright light, however, 3Com recommends that you do not look into the laser light source.*



*IEC 825, Class 1 Laser Devices are for connection only to Class 1 Laser Devices. MMF and SMF fiber optic interfaces use lasers.*

CLASS 1  
LASER PRODUCT

---

## Fast Ethernet Ports

Your Switch 3900 has 24 or 36 10/100BASE-TX ports with RJ-45 connectors. This section contains information on cabling the 10/100BASE-TX (RJ-45) ports and pin assignments for the RJ-45 connectors.

### Cabling 10/100BASE-TX (RJ-45) Ports

The Switch 3900 system's Ethernet ports are shielded RJ-45 data sockets. You can connect shielded or unshielded data cables with shielded or unshielded jacks to these data sockets.

The Ethernet ports are numbered from 1X to 24X or 1X to 36X, depending on your system. They are configured as MDI-X for direct connection to a workstation or other data terminal equipment (DTE), using straight-through twisted-pair wiring.

To connect a Switch 3900 system to a 10/100BASE-TX repeater or switch, use a crossover cable, or set the port on the connected device to MDI and use a straight-through cable.

Follow these guidelines when you cable 10/100BASE-TX connectors:

- Use two twisted-pair wires for each link.
- Use twisted-pair wire that is 22-26 AWG (0.5 millimeter) in diameter.
- Use twisted-pair wire with an impedance of between 85 and 115 Ohms.
- Verify that the length of the twisted-pair link from the system to any potential workstation location is 100 meters (328 feet) or less.

To cable a 10/100BASE-TX (RJ-45) port:

- 1 Remove the dust cover and save it for future use.
- 2 Plug the male RJ-45 connector on the 10/100BASE-TX cable into the selected port until it clicks into place.
- 3 Attach the other end of the cable to an MDI port on a workstation, repeater, or concentrator.
- 4 Repeat steps 2 and 3 for the remaining ports.

Figure 3-1 shows the cabling of a 10/100BASE-TX (RJ-45) port.

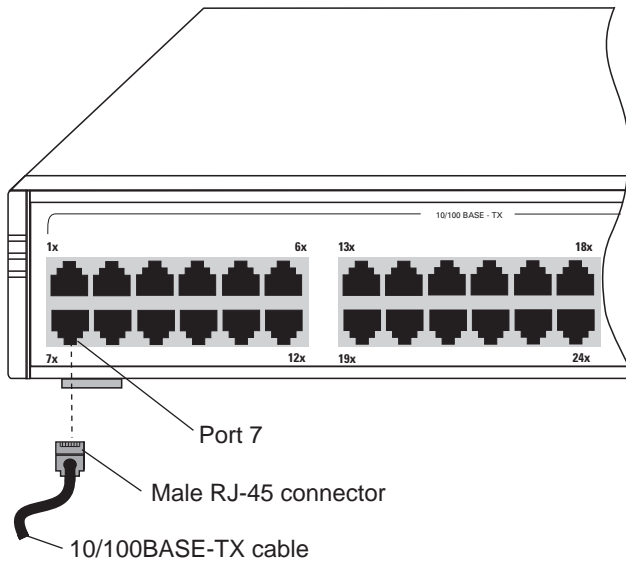

**Figure 3-1** Cabling a 10/100BASE-TX (RJ-45) Port

### 10/100BASE-TX (RJ-45) Connector Pin Assignments

Table 3-1 provides the pin assignments for the RJ-45 connectors.

**Table 3-1** 10/100 BASE-TX (RJ-45) Pin Assignments

Pin No.	Signal	Description
1	RX +	Receive +
2	RX -	Receive -
3	TX +	Transmit +
4		Not used
5		Not used
6	TX -	Transmit -
7		Not used
8		Not used

---

## Gigabit Ethernet Ports

The back panel of the Switch 3900 has one fixed Gigabit Ethernet port and slots for two optional Gigabit Ethernet modules.

### Cabling Gigabit Ethernet Ports

Both versions of the Switch 3900 (24 port and 36 port) have:

- One fixed port designated for 1000BASE-SX multimode fiber (MMF) cable with paired SC connectors.
- Two expansion slots on the back panel to hold optional Gigabit Ethernet modules. Each slot supports either the 1000BASE-LX module (SMF) or the 1000BASE-SX module (MMF).

Follow these guidelines when cabling SC connectors:

- Verify that the length of the fiber cable from the system to any location does not exceed these recommended distances:
  - Use 1000BASE-LX over 8-micron to 10-micron SMF fiber for distances of up to 3 kilometers (1.86 miles).
  - Use 1000BASE-SX over 62.5-micron MMF fiber for distances of up to 260 meters (852 feet).
  - Use 1000BASE-SX over 50-micron MMF fiber for distances of up to 525 meters (1722 feet).
- Each Gigabit Ethernet fiber cable terminates in a pair of SC connectors. The 1000BASE-LX cable connectors are blue; the 1000BASE-SX cable connectors are black. The connectors are made so that you can only insert them correctly.
- Keep the ports and connectors free of dust. Keep dust covers over each empty port. See also “Cleaning Dirty Fiber Optic Ports and Connectors” on page 6-4 for details.

To cable a Gigabit Ethernet SC port:

- 1 Remove the dust covers and save them for future use.
- 2 Attach one male connector of the SC cable connector pair to the right side of one of the Gigabit Ethernet ports on the back panel.
- 3 Attach the remaining connector of the pair to the left side of the same Gigabit Ethernet port.
- 4 To cable another Gigabit Ethernet port, repeat steps 1 through 3.

Figure 3-2 shows the Gigabit Ethernet cabling.

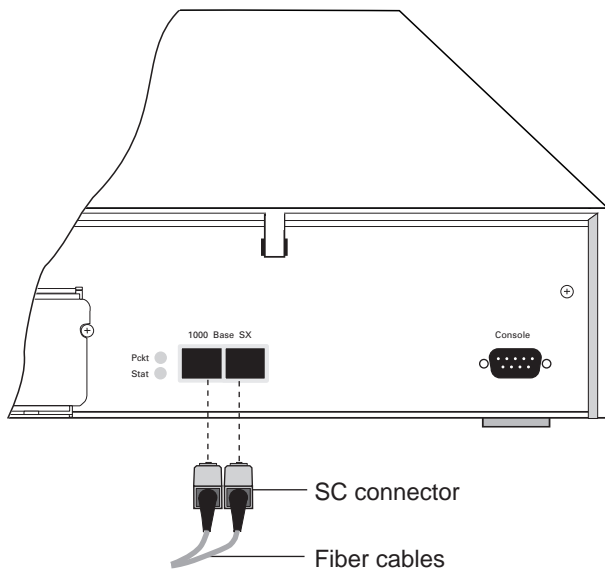

**Figure 3-2** Cabling the Fixed Gigabit Ethernet Port

## Cabling the Console Port

The Console port on the back panel provides local or remote administration:

- **For Local Administration** — The Console port provides a DB-9 connection to a local terminal or workstation that runs a terminal emulation program and acts as the Console.
- **For Remote Administration** — The Console port provides a DB-9 connection for an external modem, which you can use to connect your current Administration Console session to a modem.

To cable the Console port:

- 1 Attach the female DB-9 cable connector to the Console port's male connector and tighten the retaining screws.
- 2 Attach the other end of the DB-9 cable to your terminal.

Figure 3-3 shows the cabling of the Console port.

You can also access the system remotely through any Ethernet port using telnet. See the *SuperStack II Switch 3900 and 9300 Administration Guide*.



To use the Administration Console to configure the system for management access through the Console port, see Chapter 5.

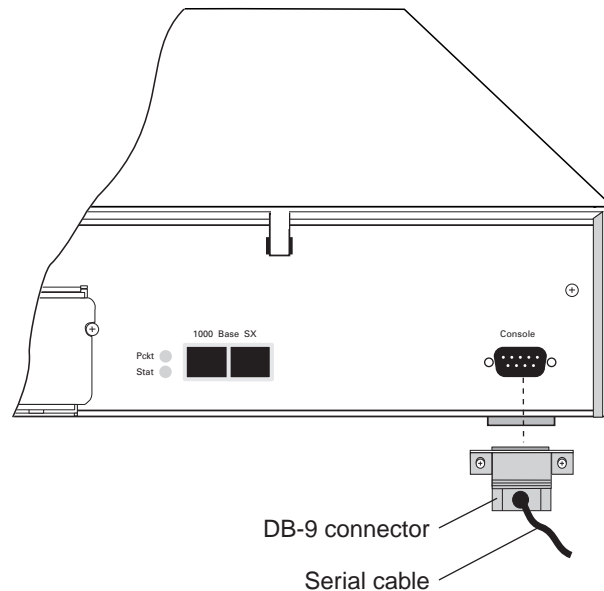

**Figure 3-3** Cabling the Console Port



## Console Port Pin Assignments

Table 3-2 shows the DB-9 pin assignments for the Console port.

**Table 3-2** Console Port DB-9 Pin Assignments

<b>Pin No.</b>	<b>Signal</b>	<b>Description</b>
1	DCD	Data Carrier Detect
2	RDA	Received Data
3	TD	Transmitted Data
4	DTR	Data Terminal Ready
5	GND	Signal Ground
6	DSR	Data Set Ready
7	RTS	Request To Send
8	CTS	Clear To Send
9	—	Not used





# SYSTEM POWER UP

This chapter contains:

- “Power Options” for the SuperStack® II Switch 3900 system
- “Power Up” instructions the Switch 3900 system
- A description of “Power-up Diagnostics”
- A list of “System Checks” after power up

For information on troubleshooting the system during power up, see Chapter 6.

---

## Power Options

You have three options for how to power up your Switch 3900 system.



*Place the system near a power receptacle. You can power down the system only by removing the power cord from the power source.*

## AC Power Cord

You can connect the system directly to a wall receptacle with the AC power cord that is shipped with the system. See “Power Up” for details.

## Optional Advanced Redundant Power System

To protect against internal power supply failures, you can connect a 3Com Advanced Redundant Power System Type 2 (RPS) to the Switch 3900 system. The RPS connector is located on the rear panel.



**CAUTION:** *Connect only a 3Com Advanced Redundant Power System Type 2 to this connector, using the external Type 2 Y cable that is shipped with the RPS.*

For details, follow the installation instructions and safety precautions that are shipped with the redundant power system.

## Optional Uninterruptible Power System

To protect against external power interruption from brownouts, blackouts, surges, and spikes, connect an uninterruptible power system (UPS) to the Switch 3900 system. Connect only a 3Com Uninterruptible Power System. Use the appropriate UPS for your region:

- United States
- European/International
- Japan

To install the UPS, follow the instructions and safety precautions that are shipped with the UPS.

## Power Up

This section provides instructions on how to set up and plug in your system. See Chapter 3 and Chapter 5 for information about cabling and configuring the Console port.



*To view error messages while the system runs power-up diagnostics, connect a terminal, a workstation, or a PC with terminal emulation to the system's Console port.*

### To Power the Switch 3900 with the RPS

To install the Advanced Redundant Power Supply (RPS) Type 2, follow the installation instructions that are shipped with the RPS and its cable.



**CAUTION:** *To prevent damage to the 3900 system and the power supply, plug the AC power cord into the Switch 3900 **before** you plug it into the redundant power system.*

### To Power the Switch 3900 from the Wall Receptacle

To get your Switch 3900 powered up and ready to operate, follow these steps:

- 1 Verify that the power outlet is near the system and easily accessible. You can turn the system off only by removing the power cord from the power source.
- 2 Plug the power cord into the system.
- 3 Plug the other end of the power cord into the power outlet. The LEDs provide information while the system runs power-up diagnostics.

## Power-up Diagnostics

The Switch 3900 system runs diagnostic software at power up. This software verifies that the system works before you add it to the network.

If any component fails during power-up diagnostics, the system either fails to power up or keeps faulty ports off-line. To verify if any ports have failed diagnostics, look at the system configuration display in the Switch 3900 Administration Console. See Chapter 4 of the *SuperStack II Switch 3900 and 9300 Administration Guide*.

During power up, the system status LEDs provide information on components in the Switch 3900 system. The system and port status LEDs and the information that they provide are shown in Figure 4-1.



*To view messages that are displayed during power-up diagnostics, connect a terminal, workstation, or PC that has terminal emulation to the system's Console port.*

## System Diagnostics

This section describes the LEDs that provide information about the system as a whole.

### Power LED Activity

- **Green** — The system is powered on; the system is running or has run diagnostics.
- **No Light** — The system has no power; no diagnostics are running.

### Fault LED Activity

- **No Light** — System diagnostics have been successfully completed and the system is operational.
- **Solid or Blinking Yellow** — The system has failed diagnostics, or some other operational error has occurred.

See Chapter 6 for troubleshooting information.

## Ethernet Port Diagnostics

This section summarizes the information displayed by the port LEDs.

### Packet LED Activity

- **No Light** — Data is not passing through the port.
- **Blinking Yellow** — Data is passing through the port.
- **Yellow** — Data is passing through the port.

### Status LED Activity

- **No Light** — The port is off-line.
- **Blinking Green** — The port is online but disabled.
- **Green** — The port is online and enabled.

See Chapter 6 for troubleshooting information.

## System and Port Status LEDs

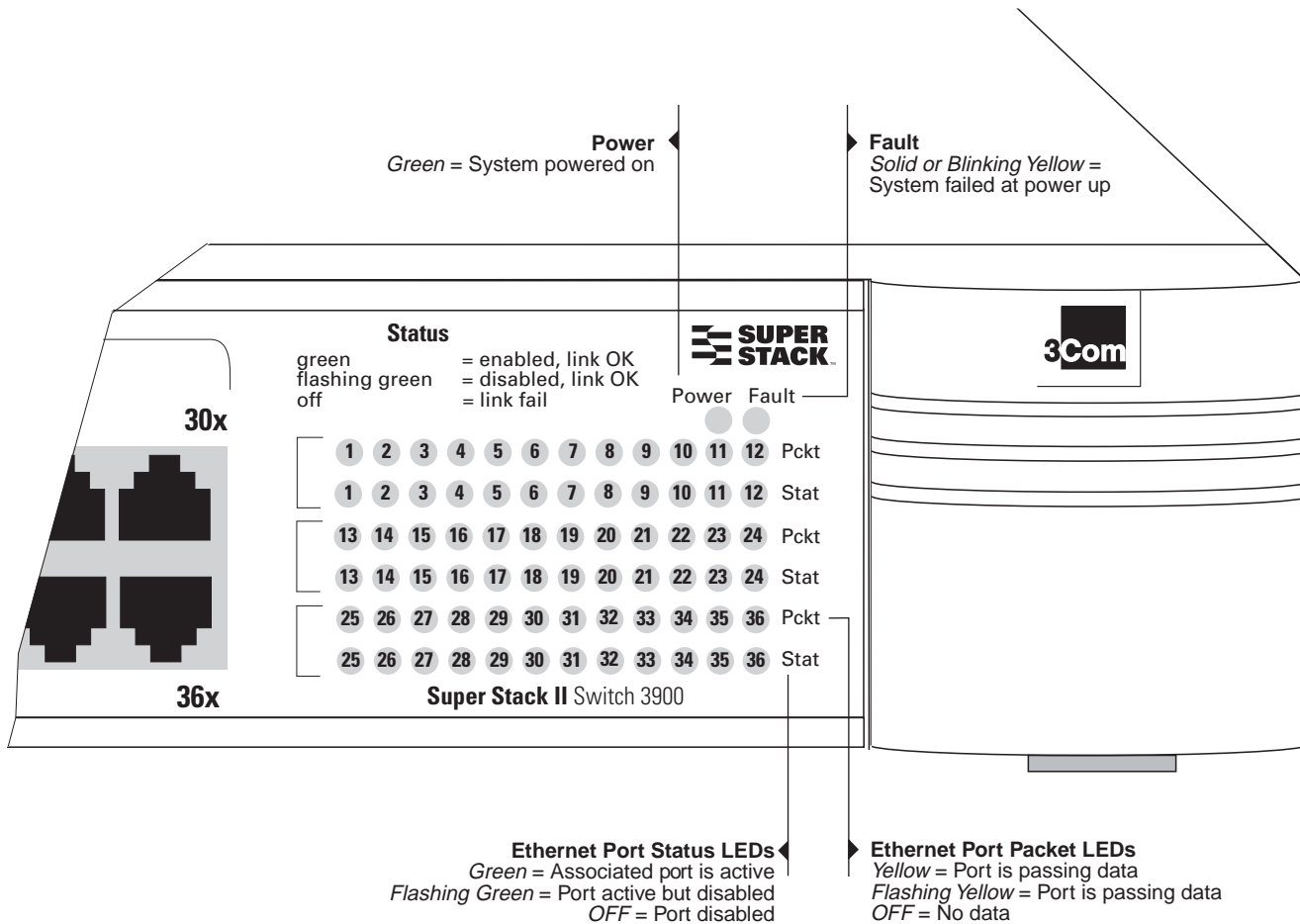

**Figure 4-1** System and Port Status LEDs on the SuperStack II Switch 3900

## System Checks

After the system has successfully completed the power-up diagnostics, check the items in Table 4-1 to verify that the system is operating correctly. If you discover abnormal conditions, see Chapter 6.

**Table 4-1** System Power-Up Checklist

Check	Description
Power-up error messages	If there is a problem during power-up, the messages are displayed in the Administration Console connection through the Console port.
Normal LED activity	<p>When the power-up diagnostics are running, the LEDs light in a certain pattern as described in the "Power-up Diagnostics" section. After you properly cable the system and the system successfully completes the power-up diagnostics, look for the following normal LED activity:</p> <p><b>System:</b></p> <ul style="list-style-type: none"> <li><b>Power</b> LED = Green</li> <li><b>Fault</b> LED = Not lit</li> </ul> <p><b>Each port:</b></p> <ul style="list-style-type: none"> <li><b>Pckt</b> status LED = Yellow</li> <li><b>Stat</b> status LED = Green</li> </ul> <p>If an LED does not light or shows a color different from the one indicated here, see Chapter 6 for information about the cause of the problem.</p>

## Next Step: Software Configuration

Your Switch 3900 system is shipped from the factory with the software installed and IEEE 802.1d bridging *disabled*. To configure your system for your particular networking environment (including customized filtering and setting up SNMP), you must first establish management access. See Chapter 5.





# 5

## QUICK SETUP FOR MANAGEMENT ACCESS

This chapter provides easy instructions for configuring the SuperStack® II Switch 3900 system for management access. After you decide how you want to manage your system, follow the configuration instructions for your preferred type of management access.

### About Switch 3900 System Management

To configure and manage your Switch 3900 system, you can use one of several applications:

- Switch 3900 Administration Console
- Other SNMP-based network management applications

The Switch 3900 Administration Console is a character-oriented, menu-driven user interface for administering the system. You can access the Administration Console in-band using the network ports through the IP network protocol. For more detailed information, see the *SuperStack II Switch 3900 and 9300 Administration Guide*.

For more complete network management, access the system with an external SNMP-based management application such as 3Com's Transcend Enterprise Manager for UNIX or Windows or another network management application.

### How Do You Want to Manage the System?

You can manage your system locally through a terminal connection or through the network with an IP connection. Table 5-1 describes the access mechanisms.

**Table 5-1** Management Access Mechanisms

Access Mechanism	Allows you to	Using
Terminal	Connect directly to the Administration Console and stay attached across system reboots	Console port
Modem	Connect remotely to the Administration Console	Console port
IP	Access the Administration Console with the rlogin or telnet commands. Or use an external SNMP management application to communicate with the Switch 3900 SNMP agent	One of the Ethernet ports assigned to an IP interface

These mechanisms are described more fully in the next sections.

## Terminal Connection

Direct access through the Console port is often preferred because it allows you to remain on the system during system boots. A Macintosh or PC attachment can use any terminal emulation program for connecting to the Console port. A workstation attachment under UNIX can use the emulator TIP. For more details, see the documentation that is shipped with your terminal emulation program.

## Modem Connection

You can manage the Administration Console using a modem by establishing a connection between your current Console session and the Console port. When you configure the external modem from the Administration Console menu system, the Console appears to be directly connected to the external modem. See the *SuperStack II 3900 and 9300 Administration Guide* for more information.



*Use the Console port for either a terminal connection or a modem connection.*

## IP Management Interface

An IP management interface is the connection between the Switch 3900 system and a subnetwork. It allows you to manage the system through any of the Ethernet ports.

With an IP interface, you can use the rlogin or telnet commands to access the Administration Console using TCP/IP from a host computer. You can also use the IP interface to manage the system with an external management application.

## Initial Management Access

The first time that you access your system, you connect through the Console port using a terminal. These are the default settings for this port: 9600 baud, 8 bits, 1 stop bit, No parity.

When you first access the Administration Console using the Console port, you see this prompt:

```
Select access level (read, write, administer):
```

- 1 At the prompt, enter:

```
administer
```

- 2 At the password prompt, press Return.

The Administration Console top-level menu appears:

```
Menu options:
```

```
-----
system      - Administer system-level functions
ethernet    - Administer Ethernet ports
bridge      - Administer bridging
ip          - Administer IP
snmp        - Administer SNMP
script      - Run a script of console commands
logout      - Logout of the Administration Console
```

```
Type ? for help.
```

```
-----
Select a menu option:
```

Use this menu to change the Console port baud setting for the terminal or to configure your system for another management access mechanism.

## Setting the Console Port Baud

To change the baud setting of the Console port:

- 1 From the top level of the Administration Console, at the `Select` menu option prompt, enter:

```
system
```

- 2 At the `system` menu, enter:

```
consoleSpeed
```

- 3 At the prompt, enter the baud setting for the Console port. The system supports these baud settings: 19200, 9600, 4800, 2400, and 1200.

The system changes the settings and displays this message:

```
Changing the baud rate may cause a loss of
communication since you are currently connected
via the serial port.
```

```
Are you sure you want to change the baud rate?
(y/n):
```

- 4 Enter **y** (for yes) or **n** (for no) at the prompt.

If you enter **y**, the baud setting is changed immediately, and you lose the ability to communicate on the Console port until you adjust the baud setting of your terminal or terminal emulator to match.

If you enter **n**, the baud setting does not change and you return to the previous menu.

## Configuring the IP Interface

These instructions include information on how to define an IP interface through which you can manage your Switch 3900 system. An IP interface contains the following parameters:

- **IP address** — This address, which is specific to your network, is used to manage the system. The IP address defines both the number of the network to which the interface is attached and its host number on that network.
- **Subnet mask** — This 32-bit number uses the same format and representation as an IP address. The subnet mask determines which bits in the IP address are interpreted as the network number, as the subnet number, and as the host number. Each IP address bit that corresponds to a 1 in the subnet mask is in the network and subnet part of the address. Each IP address bit that corresponds to a 0 is in the host part of the IP address.

To set the IP interface parameters:

- 1 From the top level of the Administration Console, enter:

```
ip interface define
```

- 2 Enter the IP address of the interface.
- 3 Enter the subnetwork mask of the subnet to which the interface is to be connected.
- 4 Enter the interface type as **VLAN**.

For more detailed instructions on assigning interface parameters, see the *SuperStack II Switch 3900 and 9300 Administration Guide*.



# 6

## TROUBLESHOOTING THE SYSTEM

This chapter explains how to troubleshoot certain problems with the SuperStack® II Switch 3900 system. It covers:

- Getting Additional Help
- Diagnosing Problems
- Cleaning Dirty Fiber Optic Ports and Connectors

---

### Getting Additional Help

If you experience system problems that are not addressed in this chapter, contact 3Com Technical Support or your service representative. Before you call, gather the following information and have it available:

- System serial number
- Maintenance agreement or warranty information and the date of purchase
- Software revision number
- Brief description of the problem

You can view some of this information in the Administration Console. From the top-level menu, enter **system display**.



*For additional information and phone numbers, see Appendix C.*

---

### Diagnosing Problems

By observing system diagnostics, you can identify and correct problems that might occur when the system powers up.

### Power Failures

If the system does not respond when you insert the power cord, see the troubleshooting suggestions in Table 6-1.

### Abnormal LED Activity

The Switch 3900 system contains several status LEDs that indicate system or port problems. If you see abnormal LED activity, see the troubleshooting suggestions in Table 6-2 (for system LEDs) and Table 6-3 (for port LEDs).

**Table 6-1** Troubleshooting Power Failures

Symptom	Possible Sources of the Problem	Steps to Take
System does not power up.	<ul style="list-style-type: none"> <li>■ System is not receiving power.</li> <li>■ Power supply malfunctioned.</li> </ul>	<ol style="list-style-type: none"> <li><b>1</b> Verify that the building's power outlet has power.</li> <li><b>2</b> Check that the power cord is firmly plugged into the system and either the building's power outlet, the redundant power system, or the uninterruptible power system.</li> <li><b>3</b> If you are using an RPS or a UPS, check that it is firmly plugged into the building's power outlet.</li> <li><b>4</b> Try another power cable.</li> <li><b>5</b> If the system still does not operate, contact 3Com Technical Support or your service representative.</li> </ol>

**Table 6-2** Troubleshooting Abnormal System LED Activity

LED Status	Possible Sources of the Problem	Steps to Take
<b>Fault</b> LED blinks yellow.	Diagnostic software is not running.	<ol style="list-style-type: none"> <li><b>1</b> Check the Administration Console display.</li> <li><b>2</b> Call 3Com Technical Support or your service representative.</li> </ol>
<b>Power</b> LED does not light.	System has failed.	<ol style="list-style-type: none"> <li><b>1</b> Shut down the system by disconnecting the power plug.</li> <li><b>2</b> Call 3Com Technical Support or your service representative.</li> </ol>

**Table 6-3** Troubleshooting Abnormal Port LED Activity

LED Status	Possible Sources of the Problem	Steps to Take
<b>Pckt</b> LED does not light.	Software error	Check the Administration Console display.
<b>Stat</b> LED does not light.	System does not recognize a connection to the port. <ul style="list-style-type: none"><li>■ Cable is not fully attached to the port.</li><li>■ Port cable is faulty.</li><li>■ Fiber optic ports or connectors are dirty.</li></ul>	<ol style="list-style-type: none"><li><b>1</b> Verify that all cables are firmly plugged into both the system's affected port and the attached device.</li><li><b>2</b> Test for faulty cables.</li><li><b>3</b> Clean the fiber optic ports and connectors. See next section.</li></ol> When the problem is corrected, the LED lights green. If the LED still does not light, contact 3Com Technical Support or your service representative.

## Cleaning Dirty Fiber Optic Ports and Connectors

Fiber optic transceivers are sensitive optical devices. Handle them carefully. If dirt collects on a fiber optic lens, the associated LED may not light. You may also notice degradation in port performance, indicated by an increase in the Link Error Rate (LER) count on a port.

To prevent dust from collecting on the fiber optic lens, keep the dust covers on the ports at all times when they are not in use.



**WARNING:** Follow all safety precautions in Chapter 3 when working with fiber optic components.

To clean a fiber optic lens, take these steps:

- 1 Remove any accumulated dust or debris from the port or connector by blowing across all surfaces with a canned air duster.

Compressed gas is recommended, such as Chemtronics' Ultrajet or the Triangle Tool Group's Liqui-Tool Dust-A-Way. Do not use commercial compressed air or "house air" because of the risk of oil contamination.

- 2 Reconnect the cable to the port to check whether dusting has corrected the problem.
- 3 Gently wipe the ports with a lint-free, nonabrasive, nonadhesive swab. Microswabs by Texwipe are recommended.
- 4 Gently wipe the connectors with a lint-free, nonabrasive wipe or pad. Texwipe pads are recommended.



*Avoid touching any surface after you clean the connectors.*



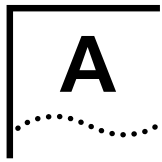

# SYSTEM SPECIFICATIONS

**Table A-1** System Specifications for the SuperStack II Switch 3900 Stackable Switch

<b>Specifications</b>	
<b>Physical Dimensions</b>	6.5 cm (H) x 44 cm (W) x 30.5 cm (D) 2.59 inches (H) x 17.32 inches (W) x 12.00 inches (D) Weight: 4.1 kg (12 lbs)
<b>Environmental Requirements</b>	
Operating Temperature	0 to 50 °C (32 to 122°F)
Operating Humidity	10 to 90% relative humidity, noncondensing
Storage Temperature	-20 to 85 °C (-4 to 185° F)
Storage Humidity	5% to 95% maximum relative humidity, noncondensing
<b>Safety</b>	
<b>Agency Certifications</b>	UL 1950, CSA 22.2 No. 950, TUV EN60950
	<b>UK General Approval Statement</b> The SuperStack™ II Switch 3900 is manufactured to the international Safety Standard EN60950 and is approved in the UK under the General Approval Number NS/G/12345/J/100003 for indirect connection to the public telecommunication network.
<b>Designed to Comply with</b>	IEC 950
<b>Electromagnetic Emissions (Agency Certification)</b>	Meets FCC part 15, Subparagraph J, Class A limits, and CISPR Class A limits Complies with EMC Council Directive 89/336/EEC, Class A limits
<b>Heat Dissipation</b>	175 watts maximum (547 BTU/hour maximum)
<b>Power Supply</b>	
Receptacles	15 ampere service receptacles, type N5/15 or NEMA 5-15R (United States and Canada only)
AC Line Frequency	47 to 63 Hz
Input Voltage Options	100 to 240 VAC
Current Rating	1.3 amperes at 120 volts

**Table A-2** Standards Supported by the SuperStack II Switch 3900

Standard Type	RFC Supported
<b>SNMP</b>	<ul style="list-style-type: none"> <li>■ SNMP protocol (RFC 1157)</li> <li>■ MIB II (RFC 1213)</li> <li>■ Ethernet MIB (RFC 1284)</li> <li>■ Bridge MIB (RFC 1286)</li> </ul>
<b>Software Installation</b>	<ul style="list-style-type: none"> <li>■ tftp (RFC 959)</li> </ul>
<b>Terminal Emulation</b>	<ul style="list-style-type: none"> <li>■ telnet (RFC 854)</li> <li>■ rlogin (RFC 1282)</li> </ul>
<b>Protocols Used for Administration</b>	<ul style="list-style-type: none"> <li>■ UDP (RFC 768)</li> <li>■ IP (RFC 791)</li> <li>■ ICMP (RFC 792)</li> <li>■ TCP (RFC 793)</li> <li>■ ARP (RFC 826)</li> </ul>

**Table A-3** LED Indicators on the SuperStack II Switch 3900

LED	Type	Description
<b>System LEDs</b>	■ <b>Power</b>	■ <b>Green</b> — System is on.
		■ <b>Off</b> — System is receiving no power.
<b>Port LEDs</b>	■ <b>Fault</b>	■ <b>Off</b> — System is operational.
		■ <b>Solid or Blinking Yellow</b> — System failed diagnostics, or some other operational failure has occurred.
		■ <b>Stat</b>
<b>Port LEDs</b>	■ <b>Stat</b>	■ <b>Off</b> — Port is off-line.
		■ <b>Blinking Green</b> — Port is online but disabled.
	■ <b>Pckt</b>	■ <b>Green</b> — Port is online and enabled.
		■ <b>Off</b> — Port is off-line.
		■ <b>Blinking Yellow</b> — Port is passing data.
	■ <b>Yellow</b> — Port is passing data.	

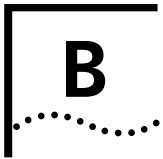

# SITE REQUIREMENTS AND SAFETY CODES

You took careful steps to plan and prepare your site for new or additional SuperStack® II Switch 3900 stackable switch systems. For your reference, this appendix summarizes the criteria that your site should meet for the Switch 3900 to operate safely and effectively.

The topics covered in this appendix:

- General Safety Requirements
- Wiring Closet Recommendations
- Distribution Rack Requirements, if you mount one or more Switch 3900 systems in a distribution rack
- Building and Electrical Codes

---

## General Safety Requirements

For safe operation, your site must meet these general safety requirements:

- All environmental requirements listed in Appendix A and in “Wiring Closet Recommendations.” Pay special attention to temperature and humidity.
- All building and electrical codes for your city and country. See relevant “Building and Electrical Codes” for more information.
- All grounding requirements listed in “Wiring Closet Recommendations” and “Distribution Rack Requirements.”

---

## Wiring Closet Recommendations

The cabling system plan at your facility probably covers most wiring closet concerns. 3Com also recommends that you check these items:

- Verify that your wiring closet meets all of the requirements in your facility cabling plan.
- Verify that your wiring closet and your facility meet all state, local, and country building and wiring codes.
- Be sure that your system is easily accessible for installation and service.
- Provide adequate overhead lighting for easy maintenance.
- Be sure that all wiring closet doors have locks to prevent unauthorized access.
- Assign wiring closet identification numbers using architectural location codes or some type of floor-grid matrix.
- Select a vinyl floor covering for your wiring closet. Concrete floors accumulate dust; carpets can cause static electricity.
- Be sure that the wiring closet floor is flat and level. If you are using distribution racks and the floor is not level, bolt the racks to the floor to prevent them from tipping over.

- Be sure that each wiring closet has a suitable ground. Ground all metal racks, enclosures, boxes, and raceways in the closet.
- Use AC power, 15-ampere service receptacles, type N5/15 or NEMA 5-15R for 120 VAC, and the other system specifications shown in Appendix A.
- Be especially sure to meet all system environmental requirements in Appendix A, such as ambient temperature and humidity.
- Be sure that the ventilation in the wiring closet is adequate to maintain a temperature below 40 °C (104 °F).
- Install a reliable air conditioning and ventilation system if you plan to have two or more Switch 3900 systems in a single wiring closet.
- To prevent overheating during nonbusiness hours, guard against the ventilation being shut down while a Switch 3900 system remains powered up.

---

## Distribution Rack Requirements

If you plan to mount your SuperStack II Switch 3900 systems in a distribution rack, verify that your rack meets the basic mechanical and space requirements described in this section.

### Protective Grounding for the Rack

To ensure that voltages induced into wiring by lightning or other disturbances are directed to ground, ground your distribution racks properly. Use a distribution rack grounding kit and a ground conductor that is carried back to earth or to another suitable building ground. To order the grounding kit, contact your sales representative.

### Space Requirements for the Rack

Provide enough space in front of and behind the system so that you can service it easily. Allow a minimum of 76 cm (30 in.) between the rack and any wall behind or in front of it. Extra room on each side is optional. See Figure B-1.



*Install your distribution rack near an easily accessible power outlet. You can power down the system only by removing the power cord from the power source.*

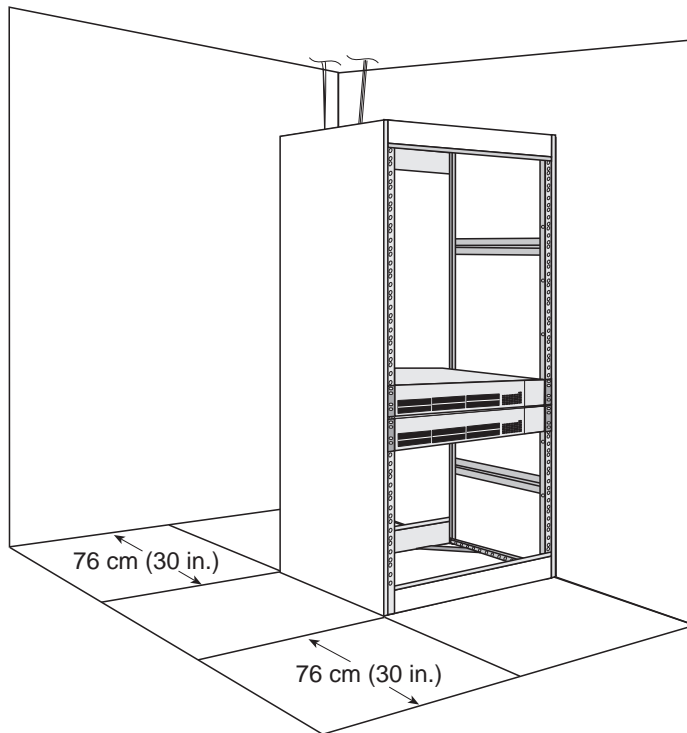

**Figure B-1** Recommended Service Access

### Mechanical Requirements for the Rack

Verify that your racks comply with the standards and requirements in your cabling system plan and conform to these conventional standards:

- In the United States, comply with EIA Standard RS-310C: Racks, Panels, and Associated Equipment.

- In countries other than the United States, comply with IEC Standard 297: Dimensions of Panels and Racks.

In addition, 3Com recommends that your distribution racks meet these requirements:

- Use an open style, 19-inch rack. The rack styles shown in Figure B-2 facilitate easy maintenance and provide excellent ventilation.
- Use a rack that has the universal mounting rail hole pattern identified in IEC Standard 297. See Figure 2-3 for a description of the universal mounting hole pattern.
- Use a rack that is made of steel.
- Install equipment in the lower half of the distribution rack to avoid making it top heavy.
- Use a rack that supports approximately 272 kg (600 lb)
- Use a rack that has adequate electrical grounding, for instance, with a distribution rack grounding kit.
- Verify that the floor under the rack is level within 5 mm ( $\frac{3}{16}$  in.). Use a floor-leveling cement compound or bolt the racks to the floor.
- Attach the rack to the wiring closet floor with 9.5 mm ( $\frac{3}{8}$  in.) lag screws or equivalent hardware.
- Brace open distribution racks if the channel thickness is less than 6.4 mm ( $\frac{1}{4}$  in.).

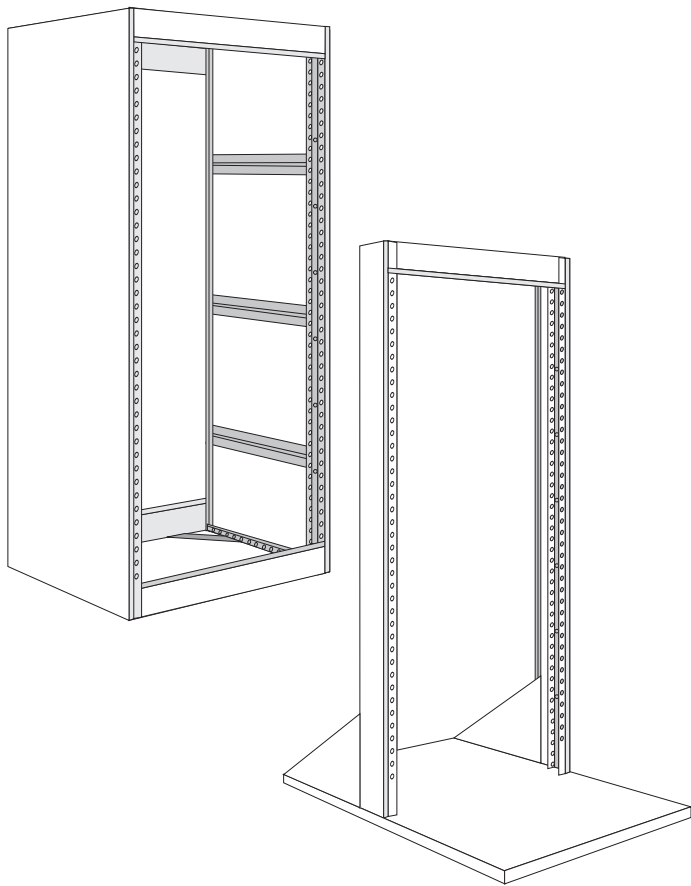

**Figure B-2** Recommended Rack Styles

---

## Building and Electrical Codes

Follow all appropriate building codes and authorities on electrical codes when planning your site and installing your cable for the Switch 3900 system.

Specific building and electrical codes vary depending on your location. The following lists are provided as resources to help you to find additional information.

### Building Codes

Major building codes:

- Uniform Building Code

International Conference of Building Officials  
(ICBO)

5360 South Workman Mill Road  
Whittier CA 90601-2298

- BOCA Basic Building Code

Building Officials and Code Administrators  
(BOCA) International, Inc.

4051 West Flossmoor Road  
Country Club Hills IL 60478-5795

- Standard Building Code (SBC)

Southern Building Code Congress International,  
Inc. (SBCCI)

900 Montclair Road  
Birmingham AL 35213-1206

## Electrical Codes

Authorities on electrical codes (USA only):

- **National Electrical Code (NEC) Classification** —

A recognized authority on safe electrical wiring. Federal, state, and local governments use NEC standards to establish their own laws, ordinances, and codes on wiring specifications. The NEC classification is published by:

National Fire Protection Association (NFPA)  
1 Batterymarch Park  
Quincy MA 02269-9101

- **Underwriters' Laboratories (UL) Listing** —

An independent research and testing laboratory. UL evaluates the performance and capability of electrical wiring and equipment to determine whether they meet certain safety standards when properly used. Acceptance is usually indicated by the words "UL Approved" or "UL Listed."

UL  
333 Pfingsten Road  
Northbrook IL 60062-2096

- **National Electrical Manufacturers Association (NEMA)** — An organization of electrical product manufacturers. Members develop consensus standards for cables, wiring, and electrical components.

NEMA  
1300 North 17th Street, Suite 1847  
Rosslyn VA 22209

- **Electronic Industries Association (EIA)** — A trade association that develops technical standards, disseminates marketing data, and maintains contact with government agencies in matters relating to electronics and related industries.

EIA  
2500 Wilson Boulevard  
Arlington VA 22201





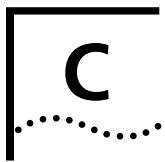

# TECHNICAL SUPPORT

3Com provides easy access to technical support information through a variety of services. This appendix describes these services.

Information contained in this appendix is correct at time of publication. For the very latest, 3Com recommends that you access the 3Com Corporation World Wide Web site.

---

## Online Technical Services

3Com offers worldwide product support 24 hours a day, 7 days a week, through the following online systems:

- World Wide Web site
- 3Com FTP site
- 3Com Bulletin Board Service (3Com BBS)
- 3ComFacts<sup>SM</sup> automated fax service

## World Wide Web Site

Access the latest networking information on the 3Com Corporation World Wide Web site by entering the URL into your Internet browser:

<http://www.3com.com/>

This service provides access to online support information such as technical documentation and

software library, as well as support options ranging from technical education to maintenance and professional services.

## 3Com FTP Site

Download drivers, patches, MIBS, and software across the Internet from the 3Com public FTP site. This service is available 24 hours a day, 7 days a week.

To connect to the 3Com FTP site, enter the following information into your FTP client:

- Hostname: **ftp.3com.com** (or **192.156.136.12**)
- Username: **anonymous**
- Password: **<your Internet e-mail address>**



*A user name and password are not needed with Web browser software such as Netscape Navigator and Internet Explorer.*

## 3Com Bulletin Board Service

The 3Com BBS contains patches, software, and drivers for 3Com products. This service is available through analog modem or digital modem (ISDN) 24 hours a day, 7 days a week.

### Access by Analog Modem

To reach the service by modem, set your modem to 8 data bits, no parity, and 1 stop bit. Call the telephone number nearest you:

Country	Data Rate	Telephone Number
Australia	Up to 14,400 bps	61 2 9955 2073
Brazil	Up to 14,400 bps	55 11 5181 9666
France	Up to 14,400 bps	33 1 6986 6954
Germany	Up to 28,800 bps	4989 62732 188
Hong Kong	Up to 14,400 bps	852 2537 5601
Italy	Up to 14,400 bps	39 2 27300680
Japan	Up to 14,400 bps	81 3 3345 7266
Mexico	Up to 28,800 bps	52 5 520 7835
P.R. of China	Up to 14,400 bps	86 10 684 92351
Taiwan, R.O.C.	Up to 14,400 bps	886 2 377 5840
U.K.	Up to 28,800 bps	44 1442 438278
U.S.A.	Up to 28,800 bps	1 408 980 8204

### Access by Digital Modem

ISDN users can dial in to the 3Com BBS using a digital modem for fast access up to 56 Kbps. To access the 3Com BBS using ISDN, use the following number:

**1 408 654 2703**

### 3ComFacts Automated Fax Service

The 3ComFacts automated fax service provides technical articles, diagrams, and troubleshooting instructions on 3Com products 24 hours a day, 7 days a week.

Call 3ComFacts using your Touch-Tone telephone:

**1 408 727 7021**

### Support from Your Network Supplier

If additional assistance is required, contact your network supplier. Many suppliers are authorized 3Com service partners who are qualified to provide a variety of services, including network planning, installation, hardware maintenance, application training, and support services.

When you contact your network supplier for assistance, have the following information ready:

- Product model name, part number, and serial number
- A list of system hardware and software, including revision levels
- Diagnostic error messages
- Details about recent configuration changes, if applicable

If you are unable to contact your network supplier, see the following section on how to contact 3Com.

## Support from 3Com

If you are unable to obtain assistance from the 3Com online technical resources or from your network supplier, 3Com offers technical telephone support services. To find out more about your support options, please call the 3Com technical telephone support phone number at the location nearest you.

When you contact 3Com for assistance, have the following information ready:

- Product model name, part number, and serial number
- A list of system hardware and software, including revision levels
- Diagnostic error messages
- Details about recent configuration changes, if applicable

Below is a list of worldwide technical telephone support numbers:

Country	Telephone Number
<b>Asia Pacific Rim</b>	
Australia	1 800 678 515
China	
From anywhere in China:	86 21 6350 1590
From Shanghai:	10 800 3656
Hong Kong	800 933 486
India	61 2 9937 5085
Indonesia	001 800 61 009
Japan	0031 61 6439
Malaysia	1800 801 777
New Zealand	0800 446 398

(continued)

Country	Telephone Number
Singapore	800 6161 463
S. Korea	
From anywhere in S. Korea:	82 2 3455 6455
From Seoul:	00798 611 2230
Taiwan	0080 611 261
Thailand	001 800 611 2000
Pakistan	61 2 9937 5085
Philippines	1235 61 266 2602

### Europe

From anywhere in Europe, call: +31 (0)30 6029900 phone  
+31 (0)30 6029999 fax

From the following European countries, you may use the toll-free numbers:

Austria	06 607468
Belgium	0800 71429
Denmark	800 17309
Finland	0800 113153
France	0800 917959
Germany	0130 821502
Hungary	00800 12813
Ireland	1 800 553117
Israel	177 3103794
Italy	1678 79489
Netherlands	0800 0227788
Norway	800 11376
Poland	0800 3111206
Portugal	05 05313416
South Africa	0800 995014
Spain	900 983125
Sweden	020 795482
Switzerland	0800 55 3072
U.K.	0800 966197

### Latin America

Argentina	541 312 3266
Brazil	55 11 523 2725, ext. 422
Colombia	571 629 4847
Mexico	01 800 849 2273

### North America

1 800 NET 3Com  
(1 800 638 3266)

## Returning Products for Repair

Before you send a product directly to 3Com for repair, you must first obtain a Return Materials Authorization (RMA) number. Products sent to 3Com without RMA numbers will be returned to the sender unopened, at the sender's expense.

To obtain an RMA number, call or fax:

Country	Telephone Number	Fax Number
Asia, Pacific Rim	65 543 6342	65 543 6348
Europe, South Africa, and Middle East	011 44 1442 435860	011 44 1442 435718
From the following European countries, you may call the toll-free numbers; select option 2 and then option 2:		
Austria	06 607468	
Belgium	0800 71429	
Denmark	800 17309	
Finland	0800 113153	
France	0800 917959	
Germany	0130 821502	
Hungary	00800 12813	
Ireland	1 800 553117	
Israel	177 3103794	
Italy	1678 79489	
Netherlands	0800 0227788	
Norway	800 11376	
Poland	0800 3111206	
Portugal	05 05313416	
South Africa	0800 995014	
Spain	900 983125	
Sweden	020 795482	
Switzerland	0800 55 3072	
U.K.	0800 966197	
Latin America	1 408 326 2927	1 408 764 6883
U.S.A. and Canada	1 800 876 3266, option 2	1 408 764 7120

# INDEX

---

## Numbers

- 10/100BASE-TX
  - cabling 3-2
  - connector pin assignments 3-3
- 1000BASE-LX module 3-4
- 1000BASE-SX module 3-4
- 3Com bulletin board service (3Com BBS) C-1
- 3Com FTP site C-1
- 3Com URL 1, C-1
- 3ComFacts fax service C-2

---

## A

- AC components
  - Redundant Power System 4-1
  - Uninterruptible Power System 4-1
- Administration Console
  - accessing 5-2
  - configuring IP addresses 5-3
- Advanced Redundant Power System (RPS) 4-1
- air conditioning
  - requirements for system B-2
- audience 1

---

## B

- baud setting
  - changing 5-3
- brackets, mounting 2-3
- building codes
  - BOCA Basic Building Code (BOCA) B-4
  - Standard Building Code (SBC) B-4
  - Uniform Building Code B-4
- bulletin board service C-1

---

## C

- cabling
  - 10/100BASE-TX (RJ-45) ports 3-2
  - 1000BASE (SC) ports 3-4, 3-5
  - Console port 3-5
  - Ethernet ports 3-2 to 3-3
  - Gigabit Ethernet ports 3-4
  - modem 3-5
  - overview 3-1
  - serial port 3-5
- cabling system plans B-3
- cautions in text
  - defined 2
- CD-ROM documentation 4
- Console port
  - baud setting 5-2
  - cabling 3-5
  - default settings 5-2
  - pin assignments 3-7
  - terminal 5-1
- conventions in text
  - defined 2
- cooling the system B-2

---

## D

- DB-9 connector pin assignments 3-5
- diagnostic signs 6-1 to 6-3
- distribution rack
  - preparing for system installation 2-3
  - requirements B-2
  - universal mounting hole pattern 2-4
- documentation
  - comments 4
  - for the Switch 3900 system 3
- documents on CD-ROM 4

---

## E

- EIA (electrical code)
  - standard equipment rack B-3
  - standards B-5
- electrical codes
  - Electronics Industry Association (EIA) B-5
  - National Electrical Code (NEC) B-5
  - National Electrical Manufacturers Association (NEMA) B-5
  - Underwriters' Laboratories (UL) Listing B-5
- environmental specifications
  - and requirements B-2
  - requirements A-1
- Ethernet LEDs 4-4, 6-3
- Ethernet Pckt LED
  - position 4-4
  - troubleshooting 6-3
- Ethernet ports, cabling 3-2 to 3-3
- Ethernet Stat LED
  - position 4-4
  - troubleshooting 6-3

---

## F

- Fault LED 4-3
  - troubleshooting 6-2
- fault tolerance 1-5
- fax service (3ComFacts) C-2
- feedback on documentation 4
- fiber
  - multimode 3-1
  - single-mode 3-1
- fiber optic cables
  - cleaning 6-4
- floor plan B-1
- FTP site C-1

---

**G**

Gigabit Ethernet  
cabling 3-4  
modules 3-4  
ports 3-4

---

**H**

hardware mounting kit 2-1  
humidity  
specifications A-1, B-2

---

**I**

ICBO (building code) B-4  
IEC Standard 297 B-3  
impedance  
twisted-pair guidelines 3-2  
installation  
distribution rack 2-3  
free-standing stack 2-2  
table-top 2-2  
integrated management 1-5  
interface parameters (IP) 5-3  
IP address 5-3  
and Switch 3900 management 5-1  
quick configuration 5-3

---

**L**

LEDs  
abnormal activity 6-1  
fiber optic safety precautions 3-1  
port status 4-4, 6-3  
system fault 4-3, 6-2  
system power 4-3, 6-2  
system status 4-3, 6-2  
troubleshooting 6-2  
local management 5-1

---

**M**

management access 1-5, 5-1  
management, Switch 3900  
IP 5-1  
modem 5-1  
terminal 5-1  
modem 3-5, 5-1  
module  
fiber optic safety 3-1  
modules  
Gigabit Ethernet 3-4  
mounting brackets 2-3  
mounting hole pattern 2-3  
mounting rails B-3  
multimode fiber  
safety precautions 3-1

---

**N**

National Fire Protection Association (NFPA) B-5  
NEC (electrical code) B-5  
NEMA (electrical code) B-5  
network supplier support C-2  
notes in text  
defined 2

---

**O**

online technical services C-1

---

**P**

pin assignments  
10/100BASE-TX (RJ-45) connectors 3-3  
Console port 3-7  
ports  
fiber optic safety 3-1

---

power  
cord 4-1  
cord, troubleshooting 6-2  
down B-2  
options 4-1  
up 4-1  
wiring B-2  
Power LED 4-3  
troubleshooting 6-2  
power system  
malfunction 6-2  
redundant 4-1  
specifications A-1  
uninterruptible 4-1  
power up  
and staging the system 4-2  
and system cabling 4-2  
diagnostics 4-2  
LED activity 4-2  
protective grounding  
wiring closet B-2  
protocols supported A-2

---

**R**

rack  
open-style B-3  
preparing 2-3  
requirements B-2  
universal mounting hole pattern 2-4  
redundant power system  
connecting 4-1  
release notes 1  
returning products for repair C-4  
RJ-45 ports 3-2

---

---

**S**

- safety
  - requirements and standards B-1
  - working with fiber optic cables and LEDs 3-1
- SBC (Standard Building Code) B-4
- SC connectors 3-4
- serial line, and management access 5-1
- serial port
  - cabling 3-5
- single-mode fiber
  - safety 3-1
- site planning
  - environmental and safety requirements B-1
  - rack requirements B-2
  - wiring closet considerations B-1
- SNMP
  - agent 5-1
  - and Switch 3900 management 5-1
  - standards supported A-2
- software release notes 1
- stacking systems 2-1
- subnet mask 5-3
- Switch 3900
  - cabling 3-1
  - cooling B-2
  - description 1-1
  - installing 2-1
  - management 5-1
  - power options 4-1
  - turning off 4-1
  - turning on 4-1, 4-2
- Switch 3900 documentation 3
- system checks 4-5
- system cooling B-2

---

**T**

- table-top installation 2-2
- technical support
  - 3Com URL C-1
  - bulletin board service C-1
  - fax service C-2
  - FTP site C-1
  - network suppliers C-2
  - product repair C-4
- temperature
  - specifications A-1
- transceiver
  - fiber optic safety precautions 3-1
- troubleshooting
  - port LED activity 6-3
  - power failures 6-2
  - system checks 4-5
  - system LED activity 6-2
- turning off the system 4-1, B-2
- turning on the system 4-1
- twisted pair
  - AWG 3-2
  - impedance 3-2
  - maximum length 3-2

---

**U**

- Uniform Building Code (UBC) B-4
- uninterruptible power system (UPS) 4-1
- URL 1, C-1

---

**V**

- ventilation
  - air conditioning B-2
  - wiring closet B-2

---

**W**

- warnings in text
  - defined 2
- wiring 3-1
- wiring closet
  - recommendations B-1
- World Wide Web (WWW) 1, C-1

---

**Y**

- Year 2000 compliance 5





# 3Com Corporation LIMITED WARRANTY

---

## HARDWARE

3Com warrants its hardware products to be free from defects in workmanship and materials, under normal use and service, for the following lengths of time from the date of purchase from 3Com or its authorized reseller:

Network Interface Cards	Lifetime
Other hardware products *unless otherwise specified above	1 year*
Spare parts and spares kits	90 days

If a product does not operate as warranted above during the applicable warranty period, 3Com shall, at its option and expense, repair the defective product or part, deliver to Customer an equivalent product or part to replace the defective item, or refund to Customer the purchase price paid for the defective product. All products that are replaced will become the property of 3Com. Replacement products may be new or reconditioned. Any replaced or repaired product or part has a ninety (90) day warranty or the remainder of the initial warranty period, whichever is longer.

## SOFTWARE

3Com warrants that the software programs licensed from it will perform in substantial conformance to the program specifications therefor for a period of ninety (90) days from the date of purchase from 3Com or its authorized reseller. 3Com warrants the media containing software against failure during the warranty period. No updates are provided. 3Com's sole obligation with respect to this express warranty shall be (at 3Com's discretion) to refund the purchase price paid by Customer for any defective software products, or to replace any defective media with software which substantially conforms to applicable 3Com published specifications. Customer assumes responsibility for the selection of the appropriate applications program and associated reference materials. 3Com makes no warranty or representation that its software products will meet Customer's requirements or work in combination with any hardware or applications software products provided by third parties, that the operation of the software products will be uninterrupted or error free, or that all defects in the software products will be corrected. For any third-party products listed in the 3Com software product documentation or specifications as being compatible, 3Com will make reasonable efforts to provide compatibility, except where the noncompatibility is caused by a "bug" or defect in the third party's product.

## YEAR 2000 WARRANTY

In addition to the Hardware Products Warranty and Software Products Warranty identified above, 3Com warrants that all Heritage 3Com products sold or licensed to Customer on and after January 1, 1998 that are date sensitive will continue performing properly with regard to such date data on and after January 1, 2000, provided that all other products used by Customer in connection or combination with the 3Com products, including hardware, software, and firmware, accurately exchange date data with the 3Com products, with the exception of those products identified at 3Com's Web site, <http://www.3com.com/products/yr2000.html>, as not meeting this standard. A

product is considered a "Heritage 3Com product" if it is a member of a product family that was manufactured by 3Com prior to its merger with US Robotics Corporation. This Year 2000 limited warranty does not apply to Heritage US Robotics Corporation products. If it appears that any such product does not perform properly with regard to such date data on and after January 1, 2000, and Customer notifies 3Com before the later of April 1, 2000, or ninety (90) days after purchase of the product from 3Com or its authorized reseller, 3Com shall, at its option and expense, provide a software update that would effect the proper performance of such product, repair such product, deliver to Customer an equivalent product to replace such product, or if none of the foregoing is feasible, refund to Customer the purchase price paid for such product.

Any software update or replaced or repaired product will carry a Year 2000 Warranty for ninety (90) days or until April 1, 2000, whichever is later.

## OBTAINING WARRANTY SERVICE

Customer must contact 3Com's Corporate Service Center or an Authorized 3Com Service Center within the applicable warranty period to obtain warranty service authorization. Dated proof of purchase may be required. Products returned to 3Com's Corporate Service Center must be preauthorized by 3Com with a Return Material Authorization (RMA) number marked on the outside of the package, and sent prepaid and packaged appropriately for safe shipment, and it is recommended that they be insured. The repaired or replaced item will be shipped to Customer, at 3Com's expense, not later than thirty (30) days after receipt of the defective product by 3Com.

*Dead- or Defective-on-Arrival.* In the event a product completely fails to function or exhibits a defect in materials or workmanship within the first forty-eight (48) hours of installation but no later than thirty (30) days after the date of purchase, and this is verified by 3Com, it will be considered dead- or defective-on-arrival (DOA) and a replacement shall be provided by advance replacement. The replacement product will normally be shipped not later than three (3) business days after 3Com's verification of the DOA product, but may be delayed due to export or import procedures. When an advance replacement is provided and Customer fails to return the defective product to 3Com within fifteen (15) days after shipment of the replacement, 3Com will charge Customer for the replacement product, at list price.

3Com shall not be responsible for any software, firmware, information, or memory data of Customer contained in, stored on, or integrated with any products returned to 3Com for repair, whether under warranty or not.

## WARRANTIES EXCLUSIVE

IF A 3COM PRODUCT DOES NOT OPERATE AS WARRANTED ABOVE, CUSTOMER'S SOLE REMEDY FOR BREACH OF THAT WARRANTY SHALL BE REPAIR, REPLACEMENT, OR REFUND OF THE PURCHASE PRICE PAID, AT 3COM'S OPTION. TO THE FULL EXTENT ALLOWED BY LAW, THE FOREGOING WARRANTIES AND REMEDIES ARE EXCLUSIVE AND ARE IN LIEU OF ALL OTHER WARRANTIES, TERMS, OR CONDITIONS, EXPRESS OR IMPLIED, EITHER IN FACT OR BY OPERATION OF LAW, STATUTORY OR OTHERWISE, INCLUDING WARRANTIES, TERMS, OR CONDITIONS OF MERCHANTABILITY, FITNESS FOR A PARTICULAR PURPOSE, AND SATISFACTORY QUALITY. 3COM NEITHER ASSUMES NOR AUTHORIZES ANY OTHER PERSON TO ASSUME FOR IT ANY OTHER LIABILITY IN CONNECTION WITH THE SALE, INSTALLATION, MAINTENANCE, OR USE OF ITS PRODUCTS.

3COM SHALL NOT BE LIABLE UNDER THIS WARRANTY IF ITS TESTING AND EXAMINATION DISCLOSE THAT THE ALLEGED DEFECT IN THE PRODUCT DOES NOT EXIST OR WAS CAUSED BY CUSTOMER'S OR ANY THIRD PERSON'S MISUSE, NEGLIGENCE, IMPROPER INSTALLATION OR TESTING, UNAUTHORIZED ATTEMPTS TO REPAIR OR MODIFY, OR ANY OTHER CAUSE BEYOND THE RANGE OF THE INTENDED USE, OR BY ACCIDENT, FIRE, LIGHTNING, OR OTHER HAZARD.

---

#### **LIMITATION OF LIABILITY**

TO THE FULL EXTENT ALLOWED BY LAW, 3COM ALSO EXCLUDES FOR ITSELF AND ITS SUPPLIERS ANY LIABILITY, WHETHER BASED IN CONTRACT OR TORT (INCLUDING NEGLIGENCE), FOR INCIDENTAL, CONSEQUENTIAL, INDIRECT, SPECIAL, OR PUNITIVE DAMAGES OF ANY KIND, OR FOR LOSS OF REVENUE OR PROFITS, LOSS OF BUSINESS, LOSS OF INFORMATION OR DATA, OR OTHER FINANCIAL LOSS ARISING OUT OF OR IN CONNECTION WITH THE SALE, INSTALLATION, MAINTENANCE, USE, PERFORMANCE, FAILURE, OR INTERRUPTION OF ITS PRODUCTS, EVEN IF 3COM OR ITS AUTHORIZED RESELLER HAS BEEN ADVISED OF THE POSSIBILITY OF SUCH DAMAGES, AND LIMITS ITS LIABILITY TO REPAIR, REPLACEMENT, OR REFUND OF THE PURCHASE PRICE PAID, AT 3COM'S OPTION. THIS DISCLAIMER OF LIABILITY FOR DAMAGES WILL NOT BE AFFECTED IF ANY REMEDY PROVIDED HEREIN SHALL FAIL OF ITS ESSENTIAL PURPOSE.

---

#### **DISCLAIMER**

Some countries, states, or provinces do not allow the exclusion or limitation of implied warranties or the limitation of incidental or consequential damages for certain products supplied to consumers or the limitation of liability for personal injury, so the above limitations and exclusions may be limited in their application to you. When the implied warranties are not allowed to be excluded in their entirety, they will be limited to the duration of the applicable written warranty. This warranty gives you specific legal rights which may vary depending on local law.

---

#### **GOVERNING LAW**

This Limited Warranty shall be governed by the laws of the State of California, U.S.A., excluding its conflicts of laws principles and excluding the United Nations Convention on Contracts for the International Sale of Goods.

**3Com Corporation**, 5400 Bayfront Plaza, Santa Clara, CA 95052-8145  
(408) 764-5000